

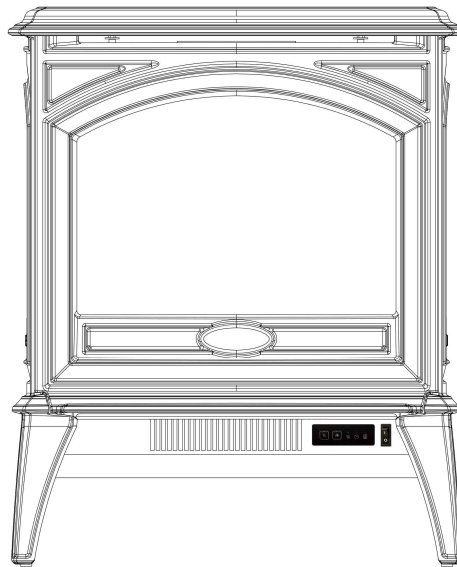

INSTALLATION AND OPERATION INSTRUCTIONS FOR

E 50

E 70



SAFETY INFORMATION



WARNING

For your safety, always comply with all warnings and safety instructions contained in this manual to prevent personal injury or property damage.

Do not store or use gasoline or other flammable vapors and liquids in the vicinity of this appliance.

INSTALLER: LEAVE OWNER'S MANUAL WITH THE APPLIANCE.

CONSUMER: RETAIN OWNER'S MANUAL FOR FUTURE REFERENCE.



WARNING: This product can expose you to chemicals including Lead in the wiring, which is [are] known to the State of California to cause birth defects or other reproductive harm. For more information visit: www.p65warnings.ca.gov

Please read and carefully follow all instructions found in this manual. Please pay special attention to the safety instructions provided in this manual. The instructions included here will assure that you have many years of dependable and enjoyable service from your Amantii product.

Table of Contents

IMPORTANT INSTRUCTIONS	3
UNPACKING AND TESTING APPLIANCE	4
GROUNDING APPLIANCE	4
CHOOSING FIREPLACE LOCATION	4
VIRTUS 50.....	5
VIRTUS 70.....	6
MEDIA OPTIONS	7
OPERATION	8
MANUAL OPERATION	8
AUTO MODE	8
REMOTE CONTROL OPERATION	9
REPLACEMENT PARTS.....	10
EXPLODED VIEW.....	11
WIRING DIAGRAM.....	12
TROUBLE SHOOTING	13
SERVICE HISTORY	14
WARRANTY	15

IMPORTANT INSTRUCTIONS

PLEASE RETAIN THIS USER GUIDE FOR FUTURE REFERENCE

When using electrical appliances, basic precautions should always be followed to reduce the risk of fire, electric shock, and injury to persons, including the following:

- 1) Read all instructions before using this fireplace
- 2) The fireplace is hot when in use. To avoid burns, do not let bare skin touch hot surfaces. Keep combustible material such as furniture, cushions, bedding, paper, clothes, curtains at least 3 feet from the front of the unit
- 3) Extreme caution is necessary when any heater is used near children and whenever the unit is left operating and unattended
- 4) Do not operate a fireplace with a damaged cord or plug, or if the heater has malfunctioned, the fireplace has dropped or damaged in any manner
- 5) Not all fireplaces are suitable for use in bathrooms or laundry facilities. Please consult with individual product literature to confirm suitability
- 6) Do not run the cord under carpeting. Do not cover cord with throw rugs, runners or the like. Arrange the cord away from traffic area and where it will not be tripped over
- 7) Do not modify this fireplace. Use it as described in the manual. Any other use not recommended by the manufacture may cause fire, shock or injury to persons
- 8) Do not use this heater with a programmer, timer, separate remote-control system or any other device that switches the heater on automatically, since a fire risk exists if the heater is covered or positioned incorrectly
- 9) Disconnect all power supply before cleaning, maintenance or relocation of the fireplace
- 10) Keep the heater clean. Do not allow any objects to enter any ventilation or exhaust opening as this may cause electric shock, fire or damage to the heater
- 11) Do not immerse the cord, plug or any part of the appliance in water or any other liquid
- 12) In order to avoid a hazard due to inadvertent resetting of the thermal cut-out, this appliance must not be supplied through an external switching device

CAUTION: Procedures and techniques, which, if not carefully followed, will result in damage to the equipment.

WARNING: Procedures and techniques, which, if not carefully followed, will expose the user to the risk of fire, serious injury, illness or death.

UNPACKING AND TESTING APPLIANCE

Carefully remove the appliance from the box.

Prior to installing the appliance, test to make sure the appliance operates properly by plugging the power supply cord into a conveniently located 120 Volt grounded outlet.

Test all aspects of its operation (manual switches, remote and heater) to make sure all components operate correctly.

As with most electronic devices, your electric fireplace has been designed to operate at temperatures between 5 °C (41°F) and 35°C (95°F). During the cold winter months, allow the fireplace to reach room temperature before turning it on.

NOTE: There may be trace of odor during the first few minutes of initial use. This is harmless, normal and will never occur again.

GROUNDING APPLIANCE

This appliance is for use on 120 volts. The cord has a plug as shown in (A). An adapter as shown in (C) is available for connecting three-blade grounding type plugs to two-slot receptacles. The green grounding lug extending from the adapter must be connected to a permanent ground such as a properly grounded outlet box. The adapter should not be used if a three-slot grounded receptacle is available.

To disconnect appliance, turn controls to off, then remove plug from outlet.

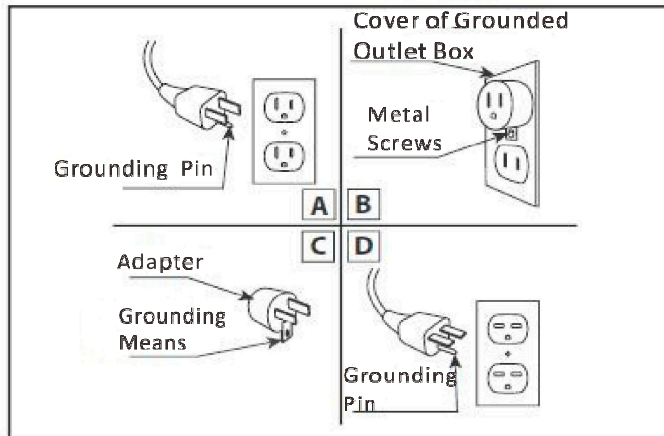

CHOOSING A LOCATION FOR THE FIREPLACE

Plan where to place and frame the fireplace. Before installation consider the following:

1. The location of the fireplace must allow for wall and ceiling clearances.
2. Consider a location where the fireplace screen will not be exposed to direct sunlight from windows or doors.
3. A 15 ampere, 120 Volt, 60 Hz branch circuit with proper ground must be available at the location. A dedicated branch circuit should be provided to avoid circuit breakers to trip or fuses to blow.

VIRTUS 50

Description	Free Standing Appliance
Voltage	120V AC 60Hz
Watts	1465W Max
NO HEATER	18.5W
MOTOR HEATER	19W
Appliance Width	23" or 58.6 cm
Appliance Height	28 1/4" or 71.7 cm
Appliance Depth	17 1/2" or 44.3 cm
Gross Weight	123.5 lbs or 56 kgs
Plug Location	Left side
Cord Length	70 7/8" or 180
BTU	5000

This appliance has been tested in accordance with the UL Standard 2021 for fixed and location dedicated electric room appliances in the United States and Canada. If you need assistance during installation, please contact your local dealer.

NOTE: This appliance must be electrically wired and grounded in accordance with local codes. In the absence of local codes, use the current CSA C22.1 Canadian Electrical Code in Canada or the ANSI/NFPA 70 National Electrical Code in the United States.

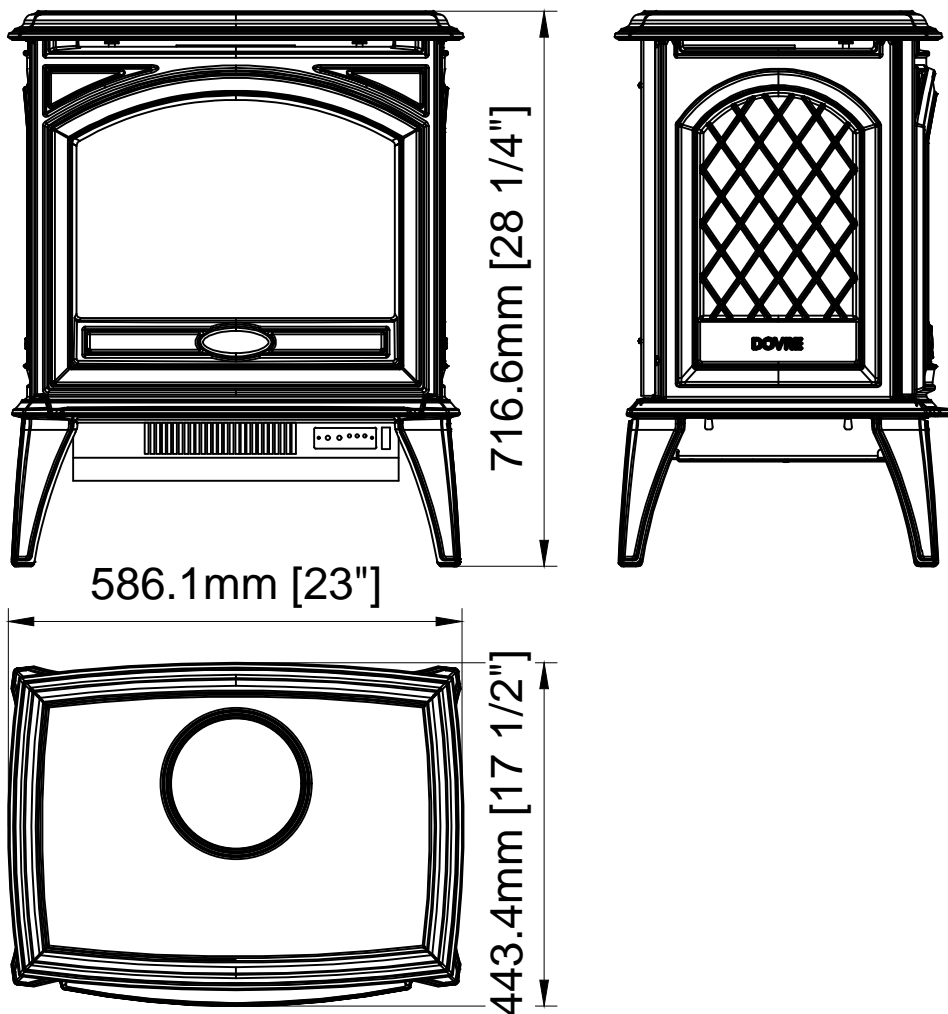

VIRTUS 70

Description	Free Standing Appliance
Voltage	120V AC 60Hz
Watts	1465W Max
NO HEATER	18.5W
MOTOR HEATER	19W
Appliance Width	28" or 70.8 cm
Appliance Height	28 1/4" or 71.6 cm
Appliance Depth	17 1/2" or 44.3 cm
Gross Weight	140.9 lbs or 63.9 kgs
Plug Location	Left side
Cord Length	180 cm
BTU	5000

This appliance has been tested in accordance with the UL Standard 2021 for fixed and location dedicated electric room appliances in the United States and Canada. If you need assistance during installation, please contact your local dealer.

NOTE: This appliance must be electrically wired and grounded in accordance with local codes. In the absence of local codes, use the current CSA C22.1 Canadian Electrical Code in Canada or the ANSI/NFPA 70 National Electrical Code in the United States.

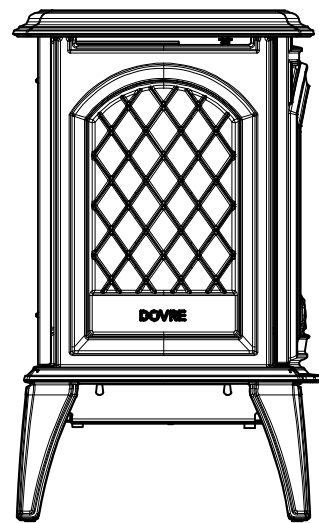
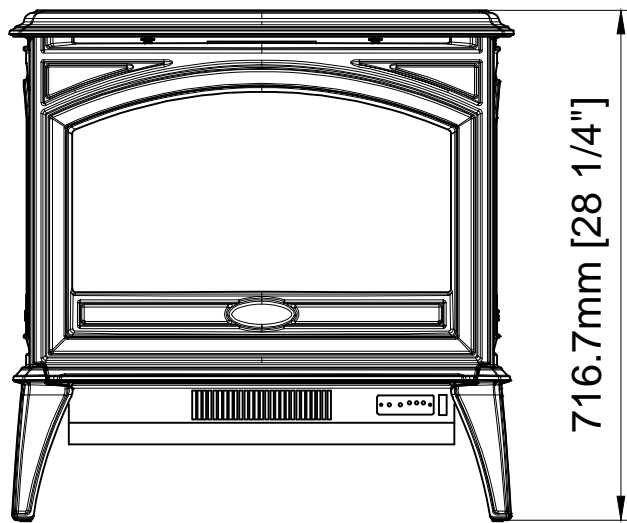

708.1mm [28"]

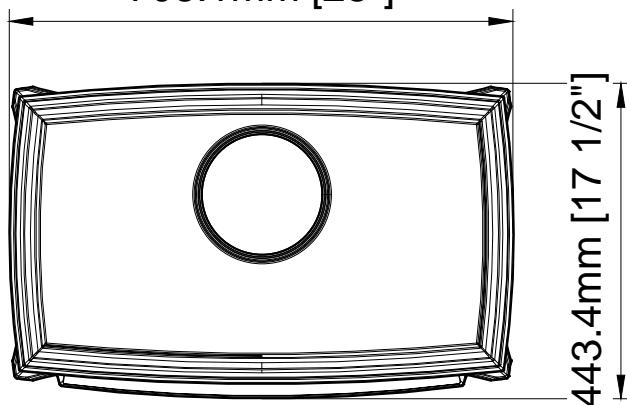

MEDIA OPTIONS

Your fireplace shipped with DESIGN-MEDIA-BIRCH-10PCE.



DESIGN-MEDIA-BIRCH-10PCE



STEP 4: Now you can decorate your fireplace.

MEDIA INSTALLATION

STEP 1: Unplug the unit and make sure controls are switched off.

STEP 2: Take off the top cover.



STEP 5: After the media has been installed, reinstall the front door and top cover.

STEP 3: Pull the front door up and take it off.



OPERATION

The fireplace can be operated by the switches located on the left front of the fireplace unit or by remote control (included).



MANUAL OPERATION



1. The main power ON/OFF switch in position O, the fireplace is OFF.
2. When main power ON/OFF switch is at position I, the fireplace is ready to use.
3. Press the  button repeatedly to set the heater to desired heat setting. The heater indicator LED will glow which shows the current heater settings.
 - a) RED 1465W HEATOUTPUT
 - b) BLUE 750W HEAT OUTPUT
 - c) PURPLE AUTO MODE

AUTO MODE

Under this mode the heater will automatically turn ON at high heat setting 1465W heat output when the room temperature drops below 22°C (72°F). When the room temperature is between 22-25°C (72-77°F) the heater output will switch to low heat setting 750W. When the room temperature goes above 25°C (77°F) the heater will be turned off and the cycle will continue. The LED indicator will be PURPLE in colour under this mode.

4. Flame effect: Press the button marked  to adjust the flame brightness. The flame brightness will cycle through –Low-Medium-High -OFF.
5. Mood light effect: Press the button marked  to change the mood light colour.

NOTE: If operated at the Low heat setting, the fireplace will not provide as much heat as in the High setting, however, the low setting will not require as much electrical power. To avoid overloading the circuit, do not plug the fireplace into a circuit that already has other appliances working connected. When the fireplace is not in use, switch off and unplug.

SAFETY CUT-OFF

- This appliance is fitted with a safety cut-off which will operate if the fireplace overheats (eg. Due to blocked air vents). For safety reasons, the fireplace will NOT automatically reset.
- To reset the appliance, disconnect the appliance from the main supply for at least 10 minutes. Reconnect the supply to the main and switch on the appliance.

REMOTE CONTROL OPERATION

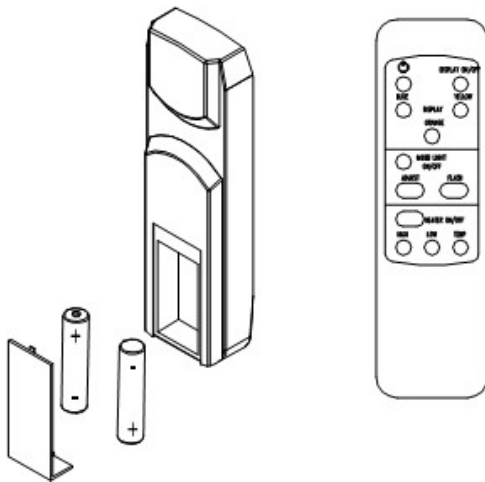

For remote to function make sure the heater is plugged in and main power switch located on the bottom left hand side is at position I.

When operating the remote make sure you point the remote to the center of the fireplace and make sure each time you press the button the buzzer inside the unit will beep once. It takes some time for the receiver to respond to the transmitter. Do not PRESS the buttons more than once within two seconds for correct operation.

Power on  button: The power-on button at top left corner of the remote is the main ON/OFF power button. This will turn off all the functions and the fireplace will be in standby mode.

DISPLAY ON/OFF button: Switches the fireplace flame and tray light On and Off. It will store the last setting.

DISPLAY BLUE button: Adjusts the blue color and brightness of flame and tray.

DISPLAY YELLOW button: Adjusts the yellow color and brightness of flame and tray.

DISPLAY ORANGE button: Adjusts the orange color and brightness of flame and tray.

MOOD LIGHT ON/OFF button: Switches the mood light On and Off..

ADJUST button: Switches the color of the mood light.

FLASH button: Switches the mood light into flash mode. This cycles through all mood light colors.

HEATER ON/OFF button: Turns the heater On and Off. It will store the last setting.

HIGH button: Press the high button to switch the heater to high heat setting 1465W.

LOW button: Press the low button to switch the heater to low heat setting 750W.

TEMP button: Press the TEMP button to switch the heater to AUTO mode. Under this mode the heater will operate as explained in the manual operation.

REPLACEMENT PARTS

This list contains replacement parts

NO	PART NUMBER		DESCRIPTION	QTY
	E 50	E 70		
2	10701381	10701382	FRONT GLASS	1
3	10702263	10702265	BOTTOM GLASS	1
4	10702262	10702264	BACK GLASS	1
7	3224505	3225505	FLICKER ASSEMBLY	1
8	601136B		LED STRIP	
	601141B		LED STRIP	
9	601097B		CIRCUIT BOARD	1
11	602067D		BLOWER AND HEATER ASSEMBLY(FRT45-187)	1
12	10105063		REMOTE CONTROL	1
13	601036		CONTROL PANEL	1
14	10101225		FLAME MOTOR	1
15	10104002		SWITCH	1

NOTE: Remote control, control panel, flame motor and switch are not shown at the exploded view.

EXPLODED VIEW

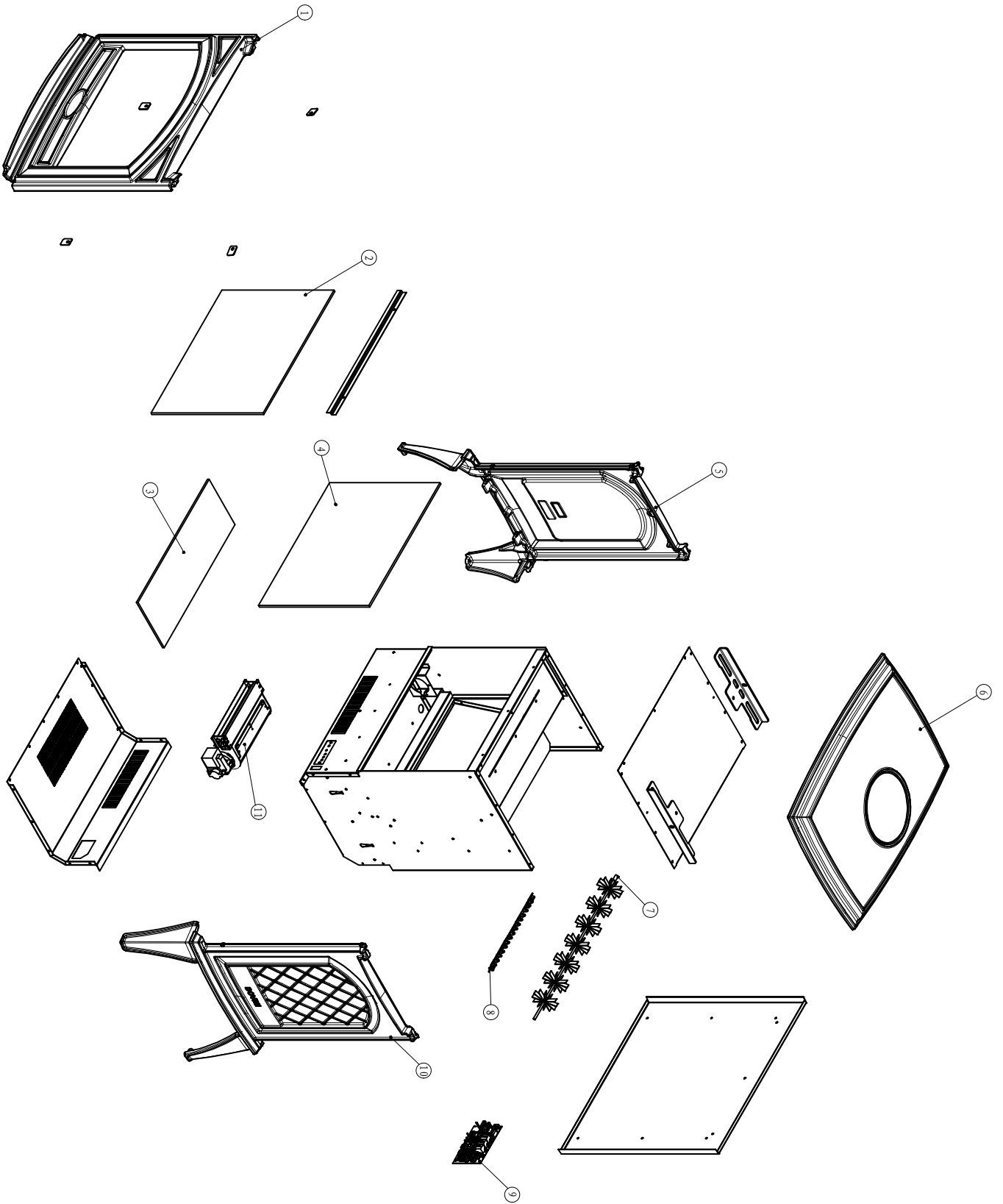

Wiring Diagram

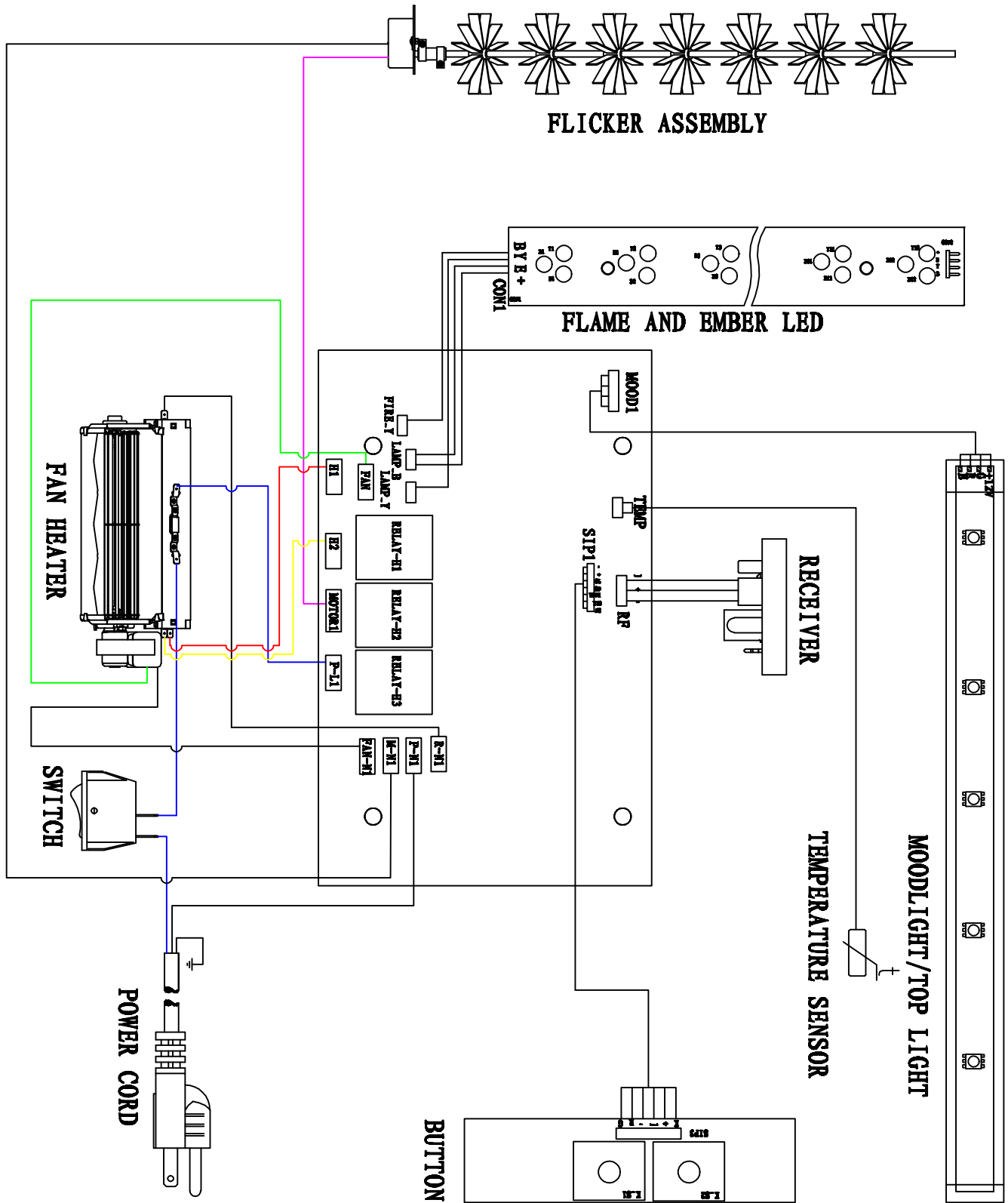

TROUBLE SHOOTING

PROBLEM	POSSIBLE CAUSE	SOLUTION
Dim or no flame	Flame LED's are burnt out	Inspect the LED's and replace them if necessary.
	Back black cloth is falling off and rolled up in the flicker	Change a flicker and back black cloth.
Ember bed is not glowing or dimming	Ember LED's are burnt out	Inspect the ember bed LED's and replace them if necessary.
Appliance turns off and will not turn on	Appliance has overheated and safety device has caused the thermal switch to disconnect	Turn off the main switch, allow appliance to cool for 10 minutes, then turn it on.
	House circuit breaker has tripped	Reset house circuit breaker.
	Appliance's fuse has blown	Replace the fuse.
Appliance will not come on when switch is flipped to ON	Appliance is not plugged into an electrical outlet	Check plug and plug in.
	Appliance has overheated and safety device has caused the thermal switch to disconnect	Turn off the main switch, allow appliance to cool for 10 minutes, then turn it on.
	Circuit board is burnt out	Inspect the circuit board and replace it if necessary.
No warm air coming out of appliance	Heater is burnt out	Inspect the burner and heater assembly and replace it if necessary.
Flame sputters	Flame motor is defective.	Call a qualified service technician and replace flame motor.
Remote Control does not work.	Low batteries. Unit switch in "O" position.	Replace AAA batteries in remote control. Turn the switch in "I" position.
Flame is fixed.	Wiring may be loose or the flame motor may be defective.	

SERVICE HISTORY

This heater must be serviced annually depending on usage.

Date	Dealer Name	Service Name	technician	Service Performed	Special Concerns

NOTES:

WARRANTY FOR PRODUCTS MANUFACTURED AFTER JANUARY 1st, 2016

Amantii Imports Corp. ("Amantii") warrants that your newly purchased Amantii electric fireplace is free from manufacturing and material defects for a period of two (2) years from the date of the first purchase, subject to the conditions and limitations contained below.

Warranty Application & Exclusions

This limited warranty applies to your newly purchased Amantii electric fireplace; the limited warranty's application is limited to purchases made in any province of Canada or in any of the 52 States of the United States of America, including the District of Columbia. Only the original purchaser of the product is eligible for coverage under this limited warranty; the warranty is not transferable.

Products excluded from this limited warranty

Light bulbs are not covered by this limited warranty and are the sole responsibility of the owner/purchaser. Amantii does not cover service or labor charges.

Warranty Coverage and Term

Products covered by this limited warranty have been tested and inspected prior to shipment and, subject to the provisions of this warranty, Amantii warrants such products to be free from defects in material and workmanship for a period of two (2) years from the date of the first purchase of such products.

The limited two (2) year warranty period for products also applies to any implied warranties that may exist under applicable law. Some jurisdictions do not allow limitations on how long an implied warranty lasts, so the above limitation may not apply to the purchaser.

All other warranties—expressed or implied—with respect to the product, its components and accessories or any obligation/liabilities on the part of Amantii are hereby expressly excluded.

Limitations to Coverage Under Limited Warranty

This limited warranty does not apply to products that have been repaired, except by Amantii or its authorized service representatives, or otherwise altered. This limited warranty further does not apply to defects resulting from misuse, abuse, accident, neglect, incorrect installation, improper maintenance or handling, or operation with an incorrect power source. Products made by other manufacturers, sold with the product or thereafter, are not covered by this limited warranty. The use of unauthorized components will render this warranty null and void.

Panorama Outdoor Units

All Panorama units that are installed outdoors or in moisture intense conditions must use the stainless steel cover. Proof of purchase of the cover is required for any warranty claims.

Defects

Defects must be brought to the attention of the selling dealer. Please have your proof of purchase, catalogue/model and serial numbers available when contacting dealer; any and all service under the limited warranty requires a proof of purchase of the product. Should a product or part covered by this limited warranty be proven to be defective, in material or workmanship, and during the two (2) year limited warranty period, Amantii will replace such defective product or part without charge. If Amantii is unable to replace such product, or if replacement is not commercially practicable or cannot be timely done, in its sole discretion Amantii may, in lieu of replacement, choose to refund the purchase price for such product or part. Amantii does not cover labor or service charges to replace said parts.

Limitations

In no event will Amantii, including without limitation any of its directors, officers, shareholders, employees, consultants, agents, heirs, executors, administrators and assigns, be liable to the purchaser or any third party, whether in contract, in tort, or on any other basis for any indirect, special, punitive, exemplary, consequential, or incidental loss, cost or damage arising out of or in connection with the sale, maintenance, use or inability to use the product, even if Amantii, including without limitation any of its directors, officers, shareholders, employees, consultants, agents, heirs, executors, administrators and assigns, have been advised of the possibility of such losses, costs or damages, or if such losses, costs or damages are foreseeable. In no event will Amantii, including without limitation any of its directors, officers, shareholders, employees, consultants, agents, heirs, executors, administrators and assigns, be liable for any direct losses, costs or damages that exceed the purchase price of the product.

Some jurisdictions do not allow the exclusion or limitation of incidental or consequential damages, so the above limitation or exclusion may not apply to the purchaser.

Application of Provincial and State Law

This limited warranty gives you specific legal rights, and you may also have other rights which vary from jurisdiction to jurisdiction. The provisions of the United Nations Convention on Contracts for the Sale of Goods shall not apply to this limited warranty or the sale of products covered by this limited warranty.

General

Amantii reserves the right to make changes at any time without notice, in design, material, specifications, prices and the right to discontinue styles and products.