

# INSTALLATION, OPERATION AND MAINTENANCE MANUAL

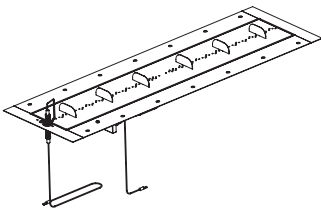

LONG GAS BURNER  
ESF.2.B.G35 7.5lbs/16.5kg

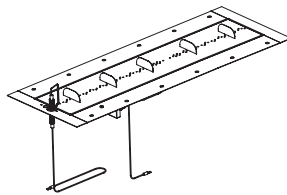

MEDIUM GAS BURNER  
ESF.1.B.G28 12.8lbs/5.8kg

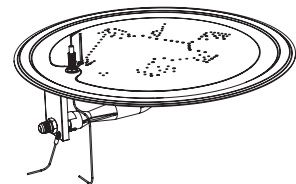

ROUND GAS BURNER  
ESF.1.B.G16 12.6lbs/5.7kg

## CAUTION

### DO NOT DISCARD THIS MANUAL

- Important operating and maintenance instructions included.
- Read, understand, and follow these instructions for safe installation and operation.

## ! DANGER !

### If you smell gas:

- Shut off gas to the appliance.
- Extinguish any open flame.
- If odor continues, keep away from the appliance and immediately call your gas supplier or fire department.

## ! WARNING !

Do not store or use gasoline, or other flammable vapors and liquids, in the vicinity of this or any other appliance.

An LP-cylinder not connected for use shall not be stored in the vicinity of this or any other appliance.

## ! WARNING !

Improper installation, adjustment, alteration, service, or maintenance can cause injury or property damage. Read the installation and maintenance instructions thoroughly before installing or servicing this equipment.

## ! DANGER !



### CARBON MONOXIDE HAZARD

This appliance can produce carbon monoxide which has no odor.

Using it in an enclosed space can kill you.

Never use this appliance in an enclosed space such as a camper, tent, car or home.

## ! WARNING !

For outdoor use only



## LISTING AND CODE APPROVALS

### A. Appliance Certification

<b>MODEL:</b>	ESF.1.B.G35, ESF.1.B.G28, ESF.1.B.G16
<b>LABORATORY:</b>	Underwriters Laboratories, Inc. (UL)
<b>TYPE:</b>	Decorative Gas-Fired Outdoor Fireplace
<b>STANDARD:</b>	Outdoor Decorative Gas Appliances ANSI Z21.97-2014 *CSA 2.41-2014

This appliance has been tested in accordance with ANSI Z21.97-2014 and CSA 2.41-2014 for Canada and has been listed by Underwriters Laboratory (UL) for installation and operation as described in these installation and operating instructions.

The installation must conform with local codes or, in the absence of local codes, ANSI Z223.1 \* NFPA 54 National fuel gas code – Natural gas and propane installation code, CSA B149.1 – or propane storage and handling code, CSA B149.2

The appliance, when installed, must be electrically grounded in accordance with local codes or, in the absence of local codes, with the National Electrical Code, ANSI/NFPA 70; or the Canadian Electrical Code, CSA C22.1, if applicable.

### B. BTU Specifications

Model	Orifice Size		Max Input BTU	
	LP	NG	LP	NG
ESF.2.B.G35	#38	#17	65000	65000
ESF.1.B.G28	#43	#31	55331	51706
ESF.1.B.G16	#43	#31	55331	51706

## EDUCATE ALL USERS

Manuals can be found on our website or by contacting your local distributor.

## WHY REGISTER YOUR WARRANTY?

Registering your warranty achieves more than simply activating your warranty - it provides our head office with the information that we require in order to communicate important safety and regulatory information to you should the need arise.

This could include things like:

- Prompt notification in the unlikely event of a potential hazard,
- Reminders about regular safety steps and maintenance procedures,
- New model announcements or accessories that suit or enhance your purchase.

It is important that we are able to communicate effectively with our customers as part of our commitment to continual improvement, consumer safety and property protection.

If you purchased your product through an external distributor, retailer or agent. MAD Design USA does not have these details on file and may have trouble sourcing them as systems and best practices vary from business to business.

Please register your warranty today. You can do this online at [www.ecosmartfire.com](http://www.ecosmartfire.com) or by sending through your details as itemized on page 21 via email to [info@mad-usa.com](mailto:info@mad-usa.com).

### MAD Design USA

5875 Green Valley Circle, Suite 100  
Culver City CA 90230  
T + 1 (888) 590.3335  
E [info@mad-usa.com](mailto:info@mad-usa.com)

---

## Contents

---

<b>Markings</b>	<b>3</b>
<b>Important Safety Information</b>	<b>3 - 4</b>
<b>Clearances</b>	<b>5</b>
<b>Before You Start</b>	<b>6</b>
<b>Gas Hookup</b>	<b>7 - 8</b>
<b>Standard Equipment Received</b>	<b>9 - 10</b>
<b>Burner Assembly - Propane</b>	<b>11 - 12</b>
<b>Burner Assembly - Natural Gas</b>	<b>13 - 14</b>
<b>Installation - Natural Gas</b>	<b>15</b>
<b>Lighting and Operating</b>	<b>16</b>
<b>Troubleshooting</b>	<b>17 - 18</b>
<b>Service and Maintenance</b>	<b>19</b>
<b>Reference Materials</b>	<b>20</b>
<b>Warranty</b>	<b>21</b>

# Markings

## Listing Label Information/Location

The model information regarding your specific appliance can be found on the rating plate attached to your burner via a metal chain. See the sample rating plate below for locations of specifications.

### DECORATIVE OUTDOOR GAS-FIRED BURNER

**This burner is for installation within approved models ONLY and is not to be installed into custom designs.**

**Model:** EcoSmart Fire GB Series  
ANSI Z21.97-2014 and CSA 2.41-2014 for Canada. Installation must conform with local codes or in the absence of local codes, ANSI Z223.1 \* NFPA 54 National Fuel Gas Code – Natural gas and propane installation code, CSA B149.1 – or propane storage and handling code CSA B149.2

**Type of Gas:** Natural Gas, Propane Gas

**WARNING:** Must Not Be Used For Cooking.

**WARNING:** For Outdoor Use Only. If stored indoors, detach and leave cylinder outdoors.

**MINIMUM CLEARANCES:** Top: 6 Ft. [72"] (1829mm)  
Sides: 2 Ft. [24"] (610mm) Bottom: 8" (203mm)

Minimum clearance from sides and back of unit to adjacent combustible construction below top of unit is 8" (203mm) from sides and 8" (203mm) from back.

Minimum horizontal clearance from sides and back of unit to adjacent vertical combustible construction extending above top of unit is 24" (610mm) from sides and 24" (610mm) from back.



MFG. DATE XX/XX  
SERIAL # XXXX DATE DE FAB. XX/XX

Model	Orifice Size		Max Input BTU	
	LP	NG	LP	NG
ESF.2.B.G35	#38	#17	65000	65000
ESF.1.B.G28	#43	#31	55331	51706
ESF.1.B.G16	#43	#31	55331	51706

**WARNING**

**Improper installation, adjustment, alteration, service or maintenance can cause injury or property damage. Refer to the owner's information manual provided with this appliance. For assistance or additional information consult a qualified installer, service agency or the gas supplier.**

EcoSmart Inc  
5875 Green Valley Circle  
Suite 100, Culver City  
CA 90230

### FOR YOUR SAFETY, READ BEFORE LIGHTING BURNER

**WARNING!**  
If you do not follow these instructions exactly, a fire or explosion may result causing property damage, personal injury, and/or loss of life.

A. This appliance must be lit manually. When lighting, follow these instructions exactly.

B. Before lighting, smell around the appliance area for gas. Be sure to smell next to the base of the appliance because some gas is heavier than air and will settle on the floor.

**WHAT TO DO IF YOU SMELL GAS:**

- Do not try to light any appliance.
- Do not touch any electric switch. Do not use any phone in your building.
- Immediately call your gas supplier from a neighbor's phone. Follow the gas supplier's instructions.
- If you cannot reach your gas supplier, call the fire department.

C. Use only your hand to turn the gas control knob or valve. Never use tools. If the valve will not turn by hand, don't try to repair it. Call a qualified service technician. Force or attempted repair may result in a fire or explosion.

D. Do not use the appliance if any part has been underwater. Immediately call a qualified service technician to inspect the appliance and replace any part which has been underwater.

**CAUTION:** The gas pressure regulator provided with this appliance must be used. This regulator is set for an outlet pressure of 10.5 inches water column.

**WARNING**

**Do not store or use gasoline or other flammable vapors and liquids in the vicinity of this or any other appliance. An LP-cylinder not connected for use shall not be stored in the vicinity of this or any other appliance.**

EcoSmart Inc  
5875 Green Valley Circle  
Suite 100, Culver City  
CA 90230

**LIGHTING INSTRUCTIONS**

1. Depress sparker button and verify a spark is being produced between the electrode tip and receiving probe.
2. Ensure control panel valve is in the "OFF" position and slowly open valve on propane tank. If using natural gas or whole-house LP, open ball valve. If not using a control valve, skip this procedure until step 3.
3. Depress sparker button and continue holding button while turning control valve to the on position. Release button once flame is present.

**TO TURN OFF GAS TO APPLIANCE**

Turn the ON/OFF valve to "OFF" position at appliance for a natural gas appliance. For an LP appliance, turn the ON/OFF valve to "OFF" at the appliance, then with a Type I or II connection, turn the valve at the LP cylinder clockwise to the "OFF" Position when the appliance is not in use.

# Important Safety Information

## PROP 65 WARNING

### Cancer and Reproductive Harm

The use of this product, as well as by-products of the combustion of propane, natural gas and/or ethanol, contain chemicals known to the State of California to cause cancer and/or other reproductive harm.

The Safe Drinking Water and Toxic Enforcement Act of 1986 referred to as Proposition 65, requires the State of California to publish a list of chemicals known to cause cancer, birth defects or reproductive harm. It also requires California business to warn the public of potential exposures to these chemicals which result from the products they use, make or distribute. This list, which must be updated at least once a year, has grown to include approximately 900 chemicals since it was first published in 1987.

The use of this product and/or the combustion of fuels, such as propane, natural gas, and/or ethanol in this product can expose you to harmful chemicals including formaldehyde, which are known to the State of California to cause cancer, and harmful chemicals including acetaldehyde, which are known to the State of California to cause birth defects and/or other reproductive harm. For more information go to [www.P65Warnings.ca.gov/](http://www.P65Warnings.ca.gov/).

The Company encourages you to use its products and propane, natural gas and/or ethanol safely. You must read and follow all use, care and manufacturer instructions for all products

## Important Safety Information

Congratulations on your purchase of this decorative gas appliance. The appliance you have selected is designed to provide safe operation, reliability and efficiency.

This manual contains instructions for the safe installation and use of your new gas appliance. Before installing and using this appliance, read the entire manual and follow the instructions and warnings carefully.

This owner's manual should be retained for future reference. If you are the installer (and not the owner) please ensure that this manual is given to the owner for them to learn about safe operation of the appliance and for future reference.



This appliance is a Decorative Gas Appliance for **OUTDOOR USE ONLY** and **MUST NOT** be used for cooking. Do not burn solid fuels in this appliance.



This gas burner is for installation within approved models **ONLY** and is not to be installed into custom designs.

The information contained in this owner's manual, unless noted otherwise, applies to all models and gas control systems.



Keep children away from the appliance. Never leave children unsupervised when the fire is operating.

In case of emergency, have on hand a multi purpose dry chemical type fire extinguisher (ABC in USA).

	<b>WARNING</b>	
 <p>If the information in these instructions is not followed exactly, a fire or explosion may result causing property damage, personal injury, or loss of life.</p>		

	<b>WARNING</b>	
<p>Improper installation, adjustment, alteration, service, or maintenance can cause injury or property damage. Read the installation and maintenance instructions thoroughly before installing or servicing this equipment.</p>		

	<b>WARNING</b>	
<p>It is imperative the burner be kept clean</p>		

	<b>WARNING</b>	
<p>Do <b>NOT</b> use this appliance if any part of it has been underwater. Immediately call a qualified service technician inspect the appliance and replace any part of the control system and any gas control which has been underwater.</p>		

	<p>Installation and service of this appliance should be performed by qualified personnel. We recommend NFI certified, factory-professionals, or technicians supervised by an NFI certified professional.</p>
---	--

### 1. EXPLOSION/FIRE HAZARD

- i. Do not operate in an area with oxygen tanks in use or if flammable vapors are present.
- ii. Never smoke while lighting the appliance.

### 2. LOCATING THE FIRE

- i. Ensure there is enough ventilation for safe operation.
- ii. Locate the appliance away from combustible materials by observing the minimum clearance distances depicted in this manual especially for items susceptible to movement.
- iii. Locate the gas hose out of pathways where people may trip over it or in areas where the hose may be subject to accidental damage.
- vi. Place the appliance on solid, flat, level surface and where it will not get excessively wet or submerged in water.

### 3. OPERATING THE FIRE

- i. Do not use if damaged or malfunctioning.
- ii. For decorative purposes only. Not suitable for continuous operation. Do not use the appliance to heat or boil water or as a cooking appliance. Do not put wood, charcoal, paper or other combustible objects in the Fire.
- iii. MAD Design USA is not liable for any damage caused by using the incorrect type of fuel.
- vi. **NEVER** leave a fire unattended.

### 4. HOT SURFACE HAZARD

- i. Due to high surface temperatures, keep children, pets, clothing and furniture away from the unit for up to 1 hour of use, as the unit is hot while in operation, contact with the appliance may cause skin burns.

### 5. USING ACCESSORIES

- i. Use only *authorised* accessories with your appliance.
- ii. To reduce the risk of fire or injury, do not modify the appliance in any way.
- iii. The Burner has not not been tested with an unvented gas log set. To reduce the risk of fire or injury, do not install an unvented gas log set into this appliance.

For decorative media you must:

- Ensure the decorative media does not interfere with the burner parts.
- Confirm quality and suitability to ensure the media will not explode, emit carbon monoxide or fumes when exposed to extreme temperature variations.
- Fire accessories must not be smaller than 1/2in (12.7mm) diameter so that the accessories cannot impede the burner parts.

- iv. Do not use fittings or spare parts, other than those available from or recommended by the manufacturer of this appliance.

If you have any questions regarding any of the above important safety information please contact your retailer or MAD Design USA.

Please store these warnings in a safe place for future reference.

## Clearances

When planning an appliance installation, it's necessary to determine the following information first:

### Environmental Conditions

**WARNING: Ensure that your fire is positioned away from flammable materials and other sources of ignition (combustible materials, gasoline and other flammable vapors and liquids) at all times. Pay very close attention to positioning the fire away from items that may move as a result of wind and drafts. For example trees/branches/curtains/paper and the like.**

The base of the burner within the model must never come into direct contact with flammable materials.

### Locating your appliance

Adequate and constant ventilation is important to keep the appliance functioning properly and safely, including ventilation of the appliance undersides. Setting the appliance without air circulation underneath can cause heat build up and improper combustion. Do not remove the feet or operate the appliance with missing feet.

1. Locate the appliance and the LP tank cover on hard, flat surface that extends the full length and width of the appliance. The appliance and the LP tank cover can be placed on combustible surface (such as wood deck) or on non-combustible material (such as concrete). Ensure all clearances to the sides and clearances above the appliance are observed at all times (see figures 1 and 2).
2. Maintain a minimum air space of 1/2" (12.5mm) between the ground surface and the underside of the appliance sidewalls by adjusting the articulating feet up or down as necessary.
3. Do not place the appliance over grass, artificial turf, carpet or any uneven surface, as this will block the airflow underneath the appliance. See figure 1.
4. Follow the same instructions above for the LP tank cover (if purchased). See figure 1.

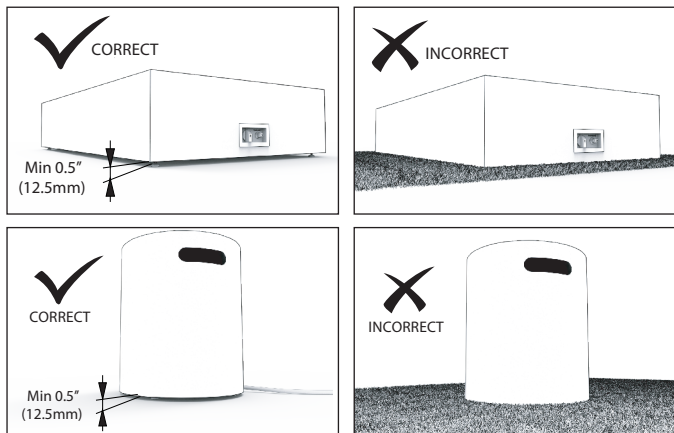

Figure 1

Position the appliance adjacent to the gas supply line or LP gas supply cylinder.

DO NOT locate the appliance where it will get excessively wet or submerged in water.

### Minimum Clearances

**Note: Measurements are distances closest to the flame**

Side clearances to fixed and stable furniture items that are not susceptible to movement such as lounges or patio furniture must remain a minimum of 24in (610mm) away from the flame at all times.

Overhead clearances to items that are susceptible to movement (e.g. Curtains/Trees) must remain a minimum of:  
- 78.7in (2000mm) away from the flame at all times.

Ceiling clearances must remain a minimum of:  
- 72in (1,829mm) to overhang from top of burner.

Please note that:

Any furniture items or fittings directly above or beside the Burner installation must be deemed suitable for heat tolerances by their manufacturer e.g. electronic items including screens and entertainment equipment, wallpaper, laminates, veneers, glues and reconstituted materials.

MAD Design USA is not liable for any injuries or damages sustained through any installation not in compliance with this manual.

**A fire extinguisher is strongly recommended.**

! WARNING !

MAD Design USA disclaims any responsibility for, and the warranty will be voided by, the following actions:

- Installation and use of any damaged components.
- Modification of the burner assembly or burner orifice.
- Installation other than as instructed in this manual.

Any such action may cause a fire hazard

! WARNING !

**Fire Risk**  
Provide adequate clearance:

- Around air openings
- For service access

Locate appliance away from traffic areas

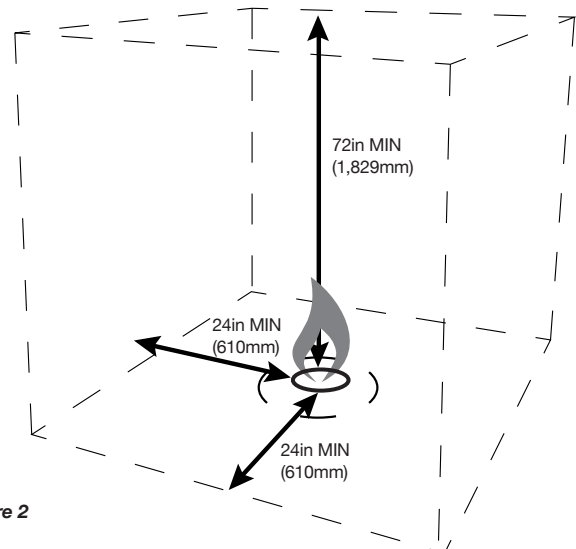

Figure 2

Clearance measurements are distances from the edge of the flame, not from the centre.

## Before You Start

### Tools and Supplies

Before beginning the installation, be sure that the following tools and supplies are at hand:

- Gloves
- Safety Glasses
- Phillips screwdriver
- Non-corrosive leak-check solution
- Adjustable Wrenches
- 1 AAA battery

### Initial Safety Inspections

Before assembling the appliance it is important to inspect the following and determine if it is safe to proceed:

- Carefully remove all burner components from packaging.
- Check for damage. Do not use damaged components.
- The hose assembly must be replaced prior to the appliance being put into operation if there is evidence of excessive abrasion or wear, or if the hose is damaged. Do not use parts other than those specified by the manufacturer.
- The burner must be replaced prior to the appliance being put into operation if it is evident that the burner is damaged. Do not use parts other than those specified by the manufacturer.
- Position the assembly in the desired location. This location must be adjacent to the gas supply line. You must have easy access to the gas valve control knob after it is installed and connected to the gas supply because the ON/OFF gas valve is used to turn the burner on and off.

The location for the installation must be out of the pathways where people may trip over it or in areas where the hose may be subject to accidental damage.

#### In addition, for LP Gas Models:

- Be certain to mount or set the LP gas cylinder on a flat stable surface and restrain it to prevent it from tipping.
- Make sure the tank valve is turned completely off (clockwise).
- Ensure the tank valve has the proper external mating threads (tank valve marked "USE WITH TYPE 1").
- Inspect the hose shipped with the appliance for any damage. Do not use if there is evidence of damage.
- **Once assembled, position the hose** out of pathways where people might trip over it or in areas where the hose might be subject to accidental damage.



**WARNING**



#### Asphyxiation Risk

- This gas appliance is for outdoor use in a well-ventilated space.
- This unit must not be installed inside an enclosed structure or unvented appliance

**CAUTION**

#### Sharp Edges

Wear protective gloves and safety glasses during installation.



**WARNING**



Inspect appliance and components for damage. Damaged parts may impair safe operation.

- Do NOT install damaged, incomplete, or substitute components.
- Report damaged parts to your dealer.

## Gas Hookup

### Fuel

Before making gas connections, ensure the appliance being installed is compatible with the available gas type.

### Gas Pressure

Proper input pressures are required for optimum performance. Gas line sizing requirements need to be made following NFPA54.

**WARNING**

**Fire Risk**  
**Explosion Risk**

Verify inlet pressures.

- High pressure may cause overfire condition.
- Low pressure may cause explosion.
- Verify minimum pressures when other household gas appliances are operating

Install regulator upstream of valve if line pressure is greater than 1/2 PSI.

Pressure requirements for appliance are shown in table below. Minimum pressures must be met when other household gas appliances are operating.

Manifold Pressure	Natural Gas	Propane
Minimum Inlet Pressure	7 in w.c	11 in w.c
Maximum Inlet Pressure	10.5 in w.c	14 in w.c

The appliance must be disconnected from the gas supply piping system during any pressures in excess of 1/2 psi (3.5 kPa).

The appliance must be isolated from the gas supply piping system during any pressure testing of the gas supply piping system at test pressures equal to or less than 1/2 psi (3.5 kPa).

### Gas Connection

Note: Have the gas supply installed in accordance with local building codes, if any. If not, follow ANSI 223.1. Installation should be done by a qualified installer approved and/or licensed as required by the locality. (In the Commonwealth of Massachusetts installation must be performed by a licensed plumber or gas fitter.

Note: A listed (and Commonwealth of Massachusetts approved) 3/8 in (9.5mm). T-handle manual shut-off valve and flexible gas connector are connected to the 3/8 in (9.5mm) control valve inlet.

If substituting for these components, please consult local codes for compliance.

Incoming gas line should be piped to the 3/8 in (9.5mm) connection on the manual shutoff valve.

**WARNING**

**Fire Risk**  
**Explosion Risk**

- Gas build-up during line purge may ignite.
- Purge should be performed by qualified technician.
- Ensure adequate ventilation.
- Ensure there are no ignition sources such as sparks or open flames.

**CAUTION:** A small amount of air will be in the gas supply lines. When first lighting appliance it will take a short time for air to purge from lines. Subsequent lighting of the unit will not require such purging. Never allow the ON/OFF valve to remain in the open position without pressing and continuing to hold Ignitor button FIRST.

**WARNING**

**Fire Risk**  
**Explosion Risk**  
**Asphyxiation Risk**

**CHECK FOR GAS LEAKS**

- Check all fittings and connections.
- Do not use open flame.
- After the gas line installation is complete, all connections must be tightened and checked for leaks with a commercially available leak-check solution. Be sure to rinse off all leak-check solution.

Fittings and connections may have loosened during shipping and handling



---

## Gas Hookup

---

### LP Gas Supply

- The pressure regulator and hose assembly supplied with LP models must be used. Replacement pressure regulators and hose assemblies must be those specified in this manual.
- The LP gas supply cylinder used with LP models must be constructed and marked in accordance with the specifications for LP gas cylinders of the U.S. Department of Transportation (DOT). Specifications for LP-Gas Cylinders, or the Standard for Cylinders, Spheres and Tubes for Transportation of Dangerous Goods and Commission, CAN/CSA-B339, as applicable
- Cylinders must be stored outdoors in a well ventilated area out of the reach of children. Disconnected cylinders must have threaded valve plugs tightly installed and must not be stored in a building, garage or any other enclosed area.
- Storage of this appliance indoors is permissible only if it has been disconnected from its fuel supply (natural gas line or LP gas cylinder).
- The LP gas cylinder supply system must be arranged for vapor withdrawal.
- The LP gas cylinder used must include a collar to protect the cylinder valve.
- When an LP model is not in use, the LP gas must be turned off at the supply cylinder.
- The specific size and capacity of the cylinder(s) to be used: 20 lb. or hard plumbed to propane tank.

**IMPROPER INSTALLATION, ADJUSTMENT, ALTERATION SERVICES, OR MAINTENANCE CAN CAUSE INJURY OR PROPERTY DAMAGE. REFER TO AND UNDERSTAND THIS MANUAL. FOR ASSISTANCE OR ADDITIONAL INFORMATION CONSULT A QUALIFIED INSTALLER, LICENSED TECHNICIAN OR THE GAS SUPPLIER.**

## Standard Equipment Received

Please ensure that all items have been received. The burners include the minimum equipment required to operate the burner safely.

### Burners

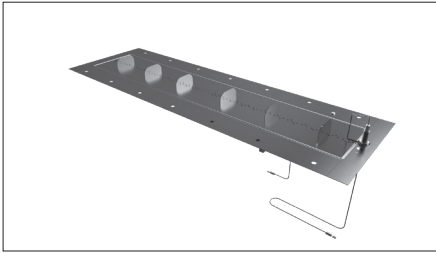

Long Gas Burner - ESF.2.B.G35

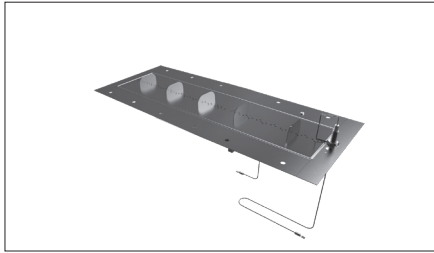

Medium Gas Burner - ESF.1.B.G28



Round Gas Burner - ESF.1.B.G16

### Included items

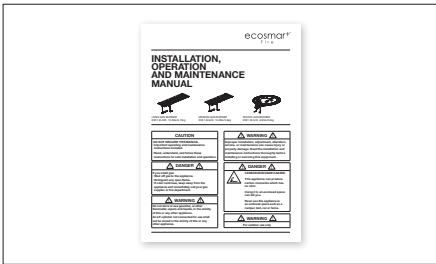

Operations Manual

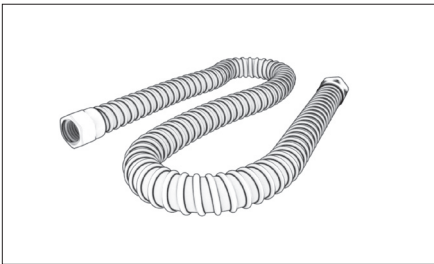

Flexible gas line (ships connected to burner)

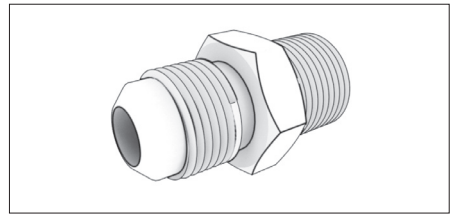

**G16 & G28 Burner**

Orifice #43 (LP - Ships Connected). Orifice #31 (NG).

**G35 Burner**

Orifice #38 (LP - Ships Connected). Orifice #17 (NG)

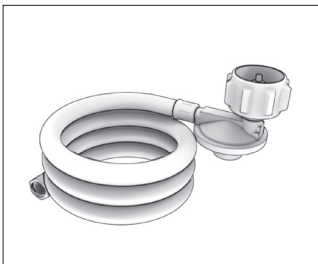

LP Hose & Regulator (10')

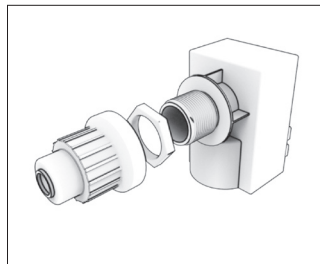

Sparker Box

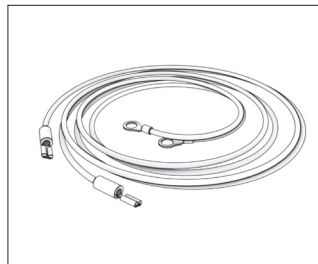

Grounding Wire 36"  
(ships connected to burner)

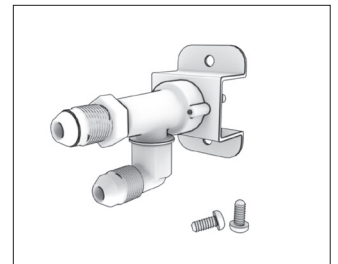

Valve and Screws  
(to connect to the control panel)

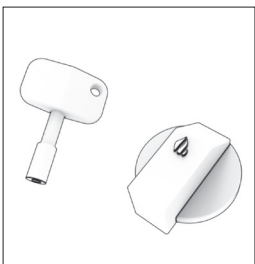

Control Knob and Key

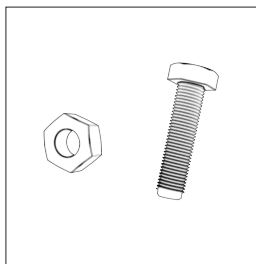

4 x Nuts and Bolts  
(for attaching linear  
burner to Adapter Plate)

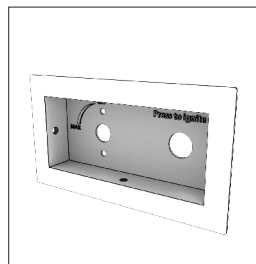

Control Panel  
(does not ship with burner /  
ships with surround unit)

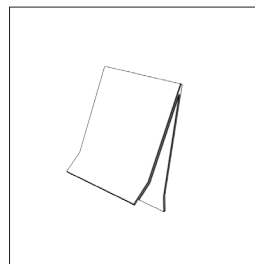

4 x Control Panel Clips  
(Fixing method 1: to secure  
control panel in place, ships  
with surround unit)

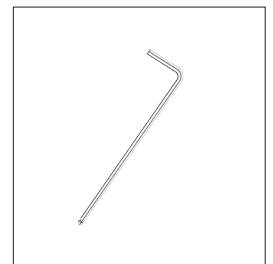

1x Allen Key  
(Fixing method 2: to secure control  
panel in place with pre-installed  
screws, ships with surround unit)

## Standard Equipment Received

### Assembling the control panel

Confirm you have received all necessary parts as illustrated on page 9.

If **clips** have been provided as the fixing method, refer to step A and follow steps 1 to 6.

If **pre-installed screws** have been provided as the fixing method, refer to steps 1 to 6

A. Insert two clips into the top and bottom of the control panel. (Four clips are supplied but only one or two will be needed in most cases).

1. Attach the valve to the back of the control panel using the provided screws. Valve must be installed as shown in drawing (with outlet on top and inlet on bottom).

2. Remove the sparker cover and plastic nut from the sparker box.

3. Place the sparker behind the control panel and insert sparker box into control panel.

4. From the front of the control panel, secure the sparker by attaching the plastic nut.

5. Insert AAA battery, ensuring the + direction of the battery is facing outward when installed.

6. Screw on the sparker box cover to hold battery in place.

i. Cap assembly completed.

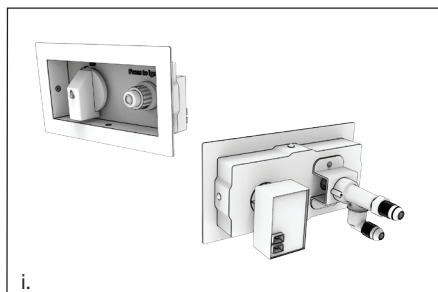
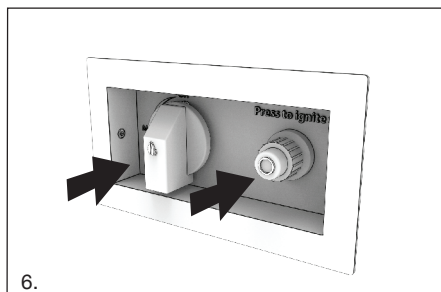
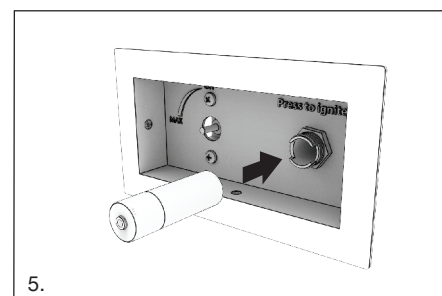
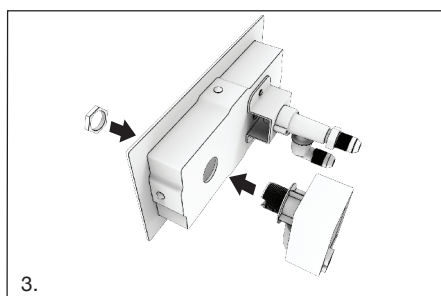
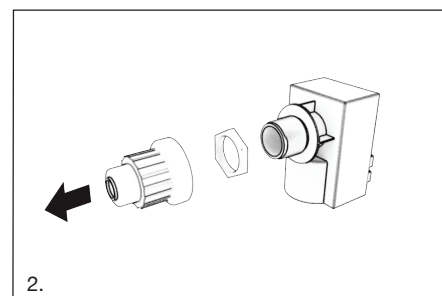
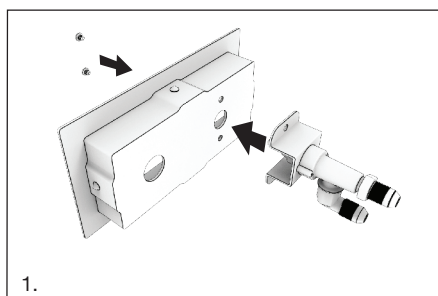
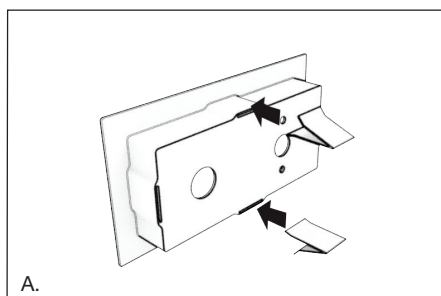

## Burner Assembly - Propane

### PROPANE

1. Unpack burner box. Remove all items and check against the items listed on page 9 of the manual to ensure all parts needed are ready.
2. **THE BURNER IS SHIPPED FOR PROPANE FUEL SOURCE.** Verify that you have the correct orifice installed by checking it against the fuel orifice chart on page 1. The orifice has the number stamped on the side. Once confirmed, check that the attached flexible gas line is tightly attached. Ensure that the air shutter is open  $\frac{1}{4}$ " (6.4mm) on each side of the air shutter.

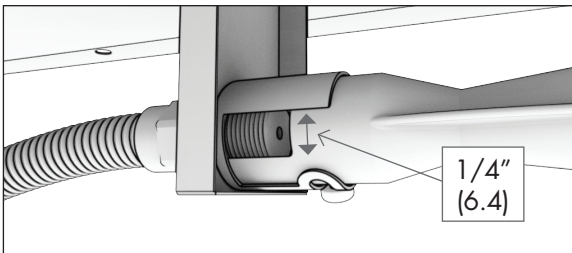

3. Ensure ignitor wire is secured to bottom of Ignitor.
4. Ensure grounding wire is secured to bottom of burner.

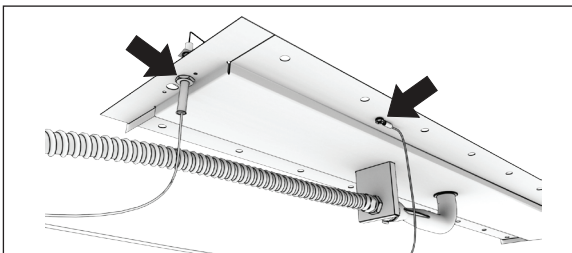

5. **Linear burners only:** (this step is not required for round burners)  
Place the tray on a large workbench or table. Attach the burner to the tray using the four bolts and nuts provided. We recommend using the 3rd hole from the outside of the long sides to securely fasten the burner to the tray. Carefully place the burner/tray assembly above the surround near the opening, without lowering it into the final location. Position the burner/tray assembly so that the gas input flexible line (where the orifice is located) is pointing towards the control plate cutout location of the surround. Feed the flexible gas line, grounding wire and the ignitor wire through the burner location opening first then place lower the burner into its final location.

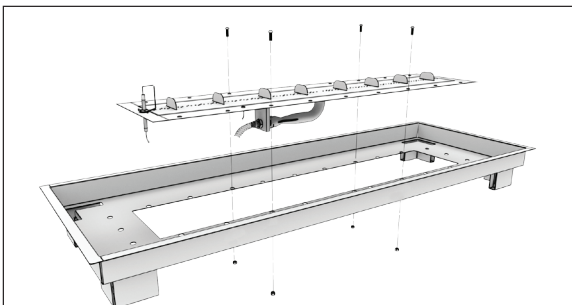

6. **Round burners only:** (this step does not apply to linear burners)  
Put the burner tray on the Surround Unit. Carefully place the burner on the Surround Unit near the tray opening – without inserting the burner into the final location. Rotate the burner to make sure the gas input flexible line is pointing towards the gas control valve location of the surround. Feed the flexible line, grounding wire and the ignitor wires through the burner location opening first then lower the burner into its final location.

7. Slide the black propane tank hose under the Surround Unit and out through the control panel opening. The other end of the black propane hose with the regulator will attach to the propane tank.

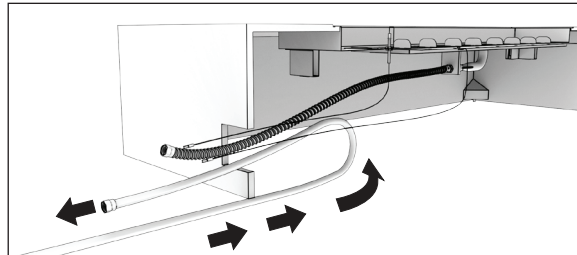
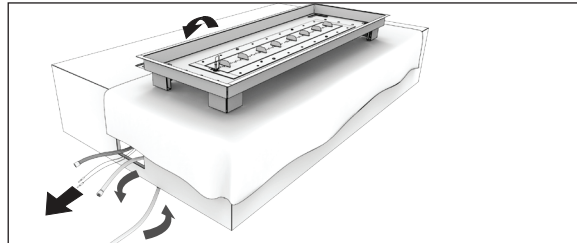

8. Pull all hoses and wires from inside the unit out through the control plate cutout.

9. Ensure you have assembled the control panel, as outlined on page 10.

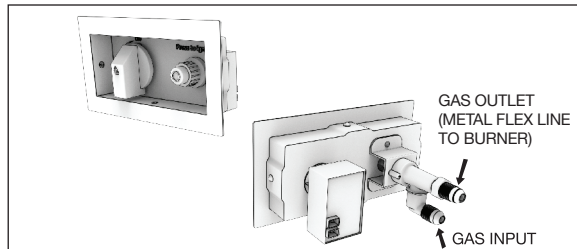

10. Using two adjustable wrenches, attach the flexible gas line to the top valve fitting (outlet). Do not overtighten.

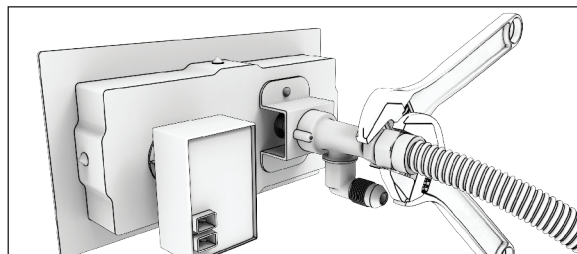

11. Using two adjustable wrenches, attach the propane tank hose to the bottom valve fitting (input). Do not overtighten.

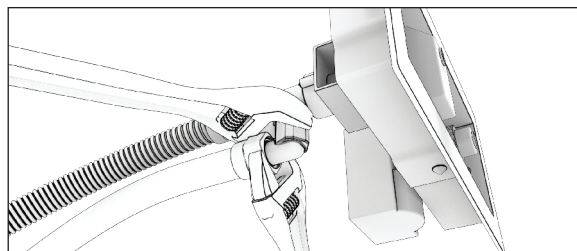

## Burner Assembly - Propane

12. Ensure propane tank is in the OFF position. Attach propane hose and included regulator to propane tank.

13. Ensure the control knob (or “key”) is in the OFF position.

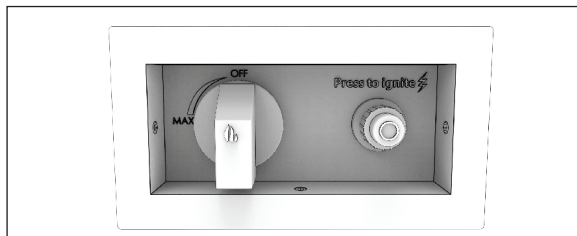

14. Use a leak detecting solution to check all connections before operation.

15. Plug the Ignitor wire and grounding wire into the back side of the sparker. These wires can be plugged into either port on the back side of the sparker box.

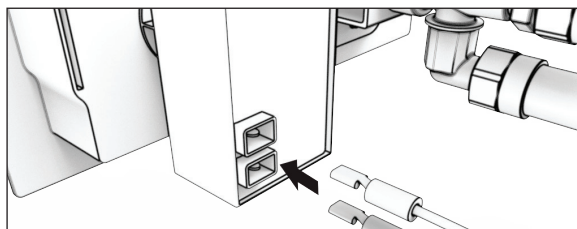

16. Insert the fully assembled Control Panel into the side of the Surround Unit, feeding the cables and wires back into the unit as needed until the Control Panel is firmly in place.

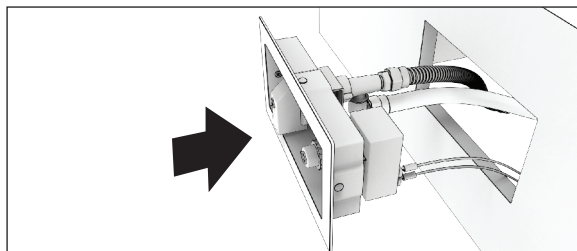

As noted on page 10 ‘Assembling the Control Panel’:

**FIGURE A: If clips have been provided as the fixing method** and you find the Control Panel is too loose, add an additional clip to the side/s to tighten up the fit. If it’s too tight, remove one of the clips until the best fit is achieved.

**FIGURE B: If screws have been provided as the fixing method,** tighten the 4 pre-installed screws with the included allen key until the control panel is screwed in place. Tighten each one so the Control Panel is set firmly in place and centered. Do not overtighten.

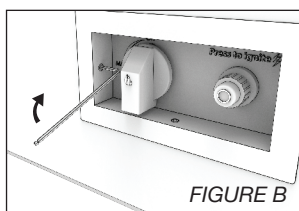
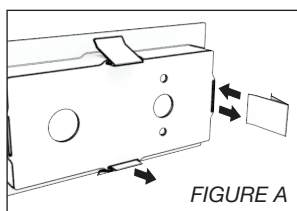

17. Fill the burner area with the included black glass media. Use all black glass charcoal provided for best effect. Keep clear of the sparker to avoid accidental blockage. Spread the media evenly while ensuring the burner is completely covered.

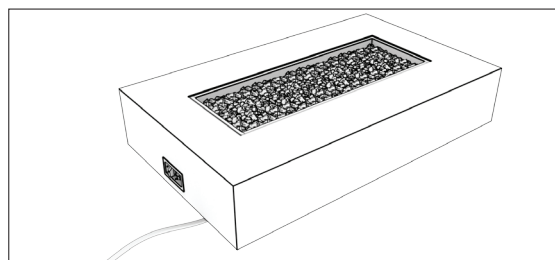

Adequate and constant ventilation is important to keep the appliance functioning properly and safely, including ventilation of the appliance undersides. Setting the appliance without air circulation underneath can cause heat build up and improper combustion. Do not remove the feet or operate the appliance with missing feet.

1. Locate the appliance and the LP tank cover on hard, flat surface that extends the full length and width of the appliance. The appliance and the LP tank cover can be placed on combustible surface (such as wood deck) or on non-combustible material (such as concrete). Ensure all clearances to the sides and clearances above the appliance are observed at all times (see figures 1 and 2).
2. Maintain a minimum air space of ½” (12.5mm) between the ground surface and the underside of the appliance sidewalls by adjusting the articulating feet up or down as necessary.
3. Do not place the appliance over grass, artificial turf, carpet or any uneven surface, as this will block the airflow underneath the appliance. See figure 1.
4. Follow the same instructions above for the LP tank cover (if purchased). See figure 1.

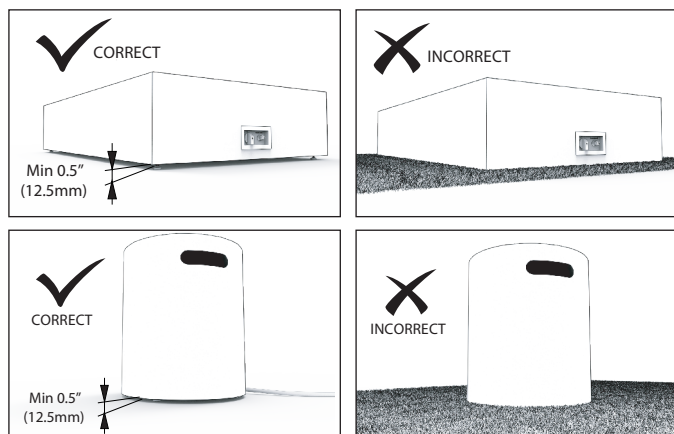

Figure 1



## Burner Assembly - Natural Gas

### NATURAL GAS

**VERY IMPORTANT:** Connection of this product to Natural Gas must be completed by a licensed gas plumber / installer only. Do not attempt to install this product with Natural Gas without a licensed installer present.

1. Unpack burner box. Remove all items and check against the items listed on page 9 of the manual to ensure all parts needed are ready. THIS BURNER IS SHIPPED FOR PROPANE FUEL SOURCE. TO CONVERT IT FOR NATURAL GAS, THE ORIFICE NEEDS TO BE REPLACED WITH THE INCLUDED ORIFICE MARKED #17 (G35) or #31 (for G16 or G28).

#### 2. REPLACING THE ORIFICE

- Turn the burner over so that the flexible hose is easily accessible. Be careful not to bend the electrode tip.
- Using two adjustable wrenches, remove the flexible hose from the burner orifice.
- G16 and G28 burners:** Using an adjustable wrench, remove the #43 orifice from the gas inlet of the burner and insert #31 orifice into the gas inlet of the burner. Do not overtighten.
- G35 burner:** Using an adjustable wrench, remove the #38 orifice from the gas inlet of the burner and insert #17 orifice into the gas inlet of the burner. Do not overtighten.

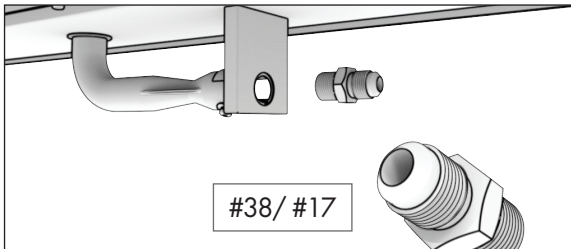

- Re-attach the flexible gas hose to the orifice. Do not overtighten.
- Adjust the air shutter to between 1/16" (1.6mm) open to completely closed on each side of the air shutter.
- Ensure ignitor wire is secured to the bottom of the ignitor.

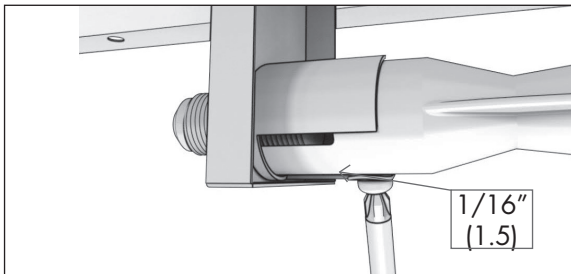

- Ensure grounding wire is secured to bottom of burner

3. **Linear burners only:** (this step does not apply to round burners) Place the tray on a large workbench or table. Attach the burner to the tray using the four bolts and nuts provided. We recommend using the 3rd hole from the outside of the long sides to securely fasten the burner. Carefully place the burner/tray assembly above the surround near the opening, without lowering it into the final location. Position the burner/tray assembly so that the gas input flexible line (where the orifice is located) is pointing towards the control plate cutout location of the surround.

Feed the flexible gas line, grounding wire and the ignitor wire through the burner location opening first then lower the burner/tray assembly into its final location.

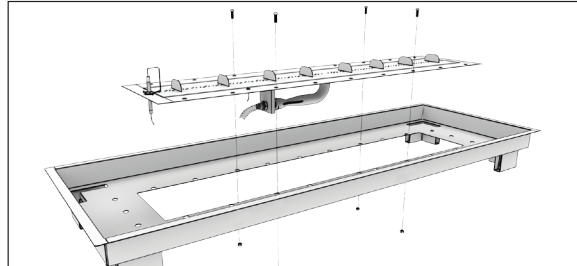

4. **Round burners only:** (this step does not apply to linear burners) Put the burner tray on the Surround Unit. Carefully place the burner on the Surround Unit near the opening, without inserting the burner into the final location. Rotate the burner to make sure the gas input flexible line is pointing towards the gas control valve location of the surround. Feed the flexible line, grounding wire and the ignitor wires through the burner location opening first then lower the burner into its final location.

5. Pull all hoses and wires from inside the unit out through the control plate cutout.

6. Route the natural gas line from below the Surround Unit out through the control panel opening.

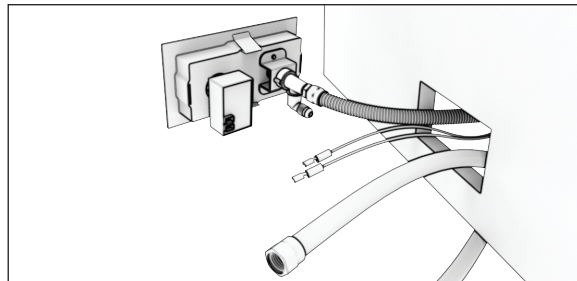

7. Ensure you have assembled the control panel, as outlined on page 10.

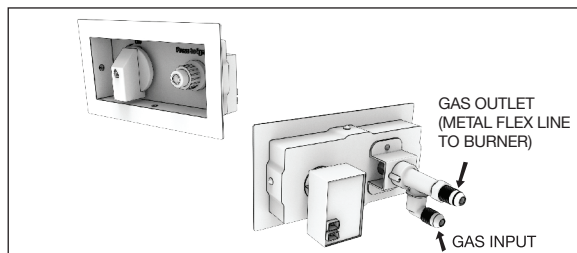

8. Using two adjustable wrenches, attach the flexible gas line to the top valve fitting (outlet). Do not overtighten.

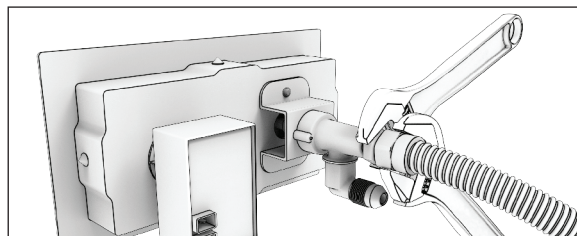

## Burner Assembly - Natural Gas

9. Using two adjustable wrenches, attach the natural gas line to the bottom valve fitting (input). Do not overtighten. It is strongly recommended to place a manual shutoff valve in the natural gas line before it reaches the valve on the control panel.

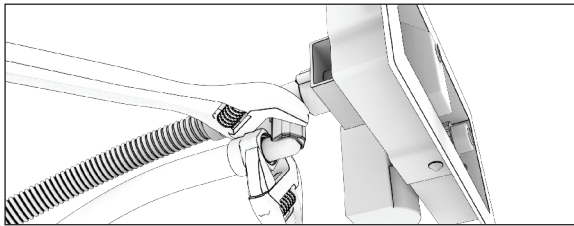

10. Ensure the control knob (or “key”) is in the OFF position.

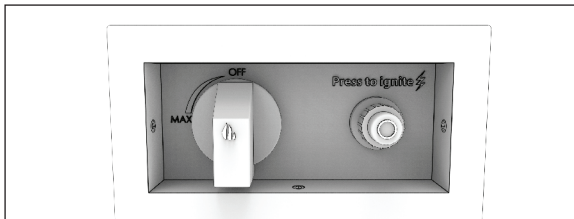

11. Use a leak detecting solution to check all connections before operation.

12. Plug the ignitor wire and grounding wire into the back side of the sparker. These wires can be plugged into either port on the back side of the sparker box.

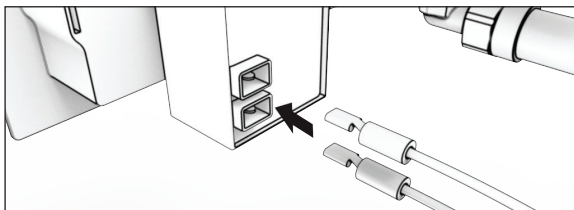

13. Insert the fully assembled Control Panel into the side of the Surround Unit, feeding the cables and wires back into the unit as needed until the Control Panel is firmly in place.

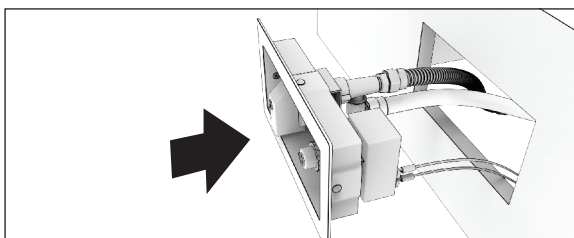

As noted on page 10 ‘Assembling the Control Panel’:

**FIGURE A:** If clips have been provided as the fixing method and you find the Control Panel is too loose, add an additional clip to the side/s to tighten up the fit. If it’s too tight, remove one of the clips until the best fit is achieved.

**FIGURE B:** If screws have been provided as the fixing method, tighten the 4 pre-installed screws with the included allen key until the control panel is screwed in place. Tighten each one so the Control Panel is set firmly in place and centered. Do not overtighten.

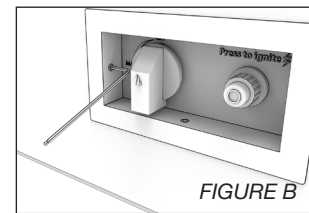
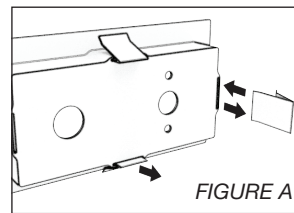

14. Fill the burner area with the included black glass media. Use all black glass charcoal provided for best effect. Keep clear of the sparker to avoid accidental blockage. Spread the media evenly while ensuring the burner is completely covered.

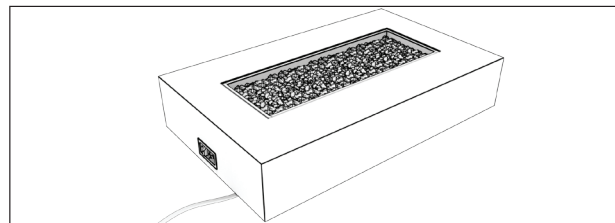

Adequate and constant ventilation is important to keep the appliance functioning properly and safely, including ventilation of the appliance undersides. Setting the appliance without air circulation underneath can cause heat build up and improper combustion. Do not remove the feet or operate the appliance with missing feet.

1. Locate the appliance and the LP tank cover on hard, flat surface that extends the full length and width of the appliance. The appliance and the LP tank cover can be placed on combustible surface (such as wood deck) or on non-combustible material (such as concrete). Ensure all clearances to the sides and clearances above the appliance are observed at all times (see figures 1 and 2).
2. Maintain a minimum air space of ½” (12.5mm) between the ground surface and the underside of the appliance sidewalls by adjusting the articulating feet up or down as necessary.
3. Do not place the appliance over grass, artificial turf, carpet or any uneven surface, as this will block the airflow underneath the appliance. See figure 1.
4. Follow the same instructions above for the LP tank cover (if purchased). See figure 1.

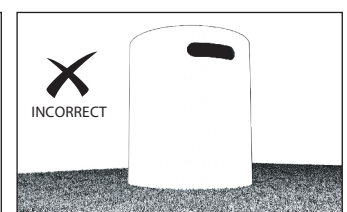
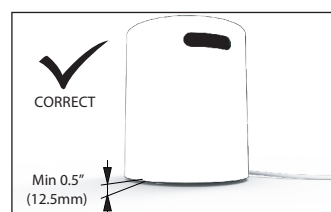
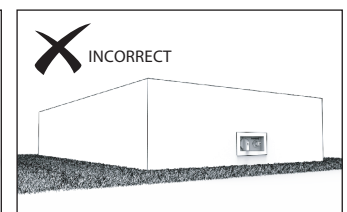
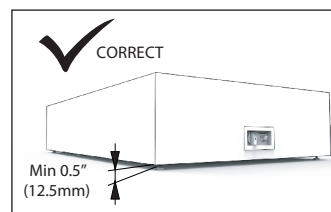

Figure 1

WARNING

**Do not burn without black glass charcoal on burner.**

## Installation - Natural Gas

### Natural Gas Supply Installation Guidelines

1. The gas supply line must have enough capacity to supply the burner with its rated gas output.
2. The flame output may be too low if the gas line is too small.
3. Smooth walled pipe should be used as a supply line. Excessive corrugated line will cause unwanted restriction and potential noise due to gas flow.
4. Gas pressure at the unit should be within 5-7 in. WC to keep restriction to a minimum.
5. Ensure that the length of the gas line and pipe diameter is properly sized for the burner output (see Pipe Sizing Chart below). Add 1' to 5' to the line length for every elbow or additional fitting. If you have another natural gas appliance sharing the same line, add the BTU output to provide to provide the proper pipe size.

### Natural Gas Pipe Sizing Chart\*

Length of Pipe in Feet	Size of Pipe in Inches (inside diameter)		
	1/2"	3/4"	1"
10	108,000	230,000	387,000
20	75,000	160,000	280,000
30	61,000	129,000	224,000
40	52,000	110,000	196,000
50	46,000	98,000	177,000
60	42,000	89,000	159,000
70	38,000	82,000	149,000
80	36,000	46,000	140,000
90	33,000	71,000	133,000
100	32,000	68,000	125,000
125	28,000	60,000	117,000
150	25,000	54,000	105,000
175	23,000	50,000	93,000

\*Maximum delivery capacity of pipes in BTU/hour at different diameters and lengths for an initial pressure of 7-inch water column. **Note: 1 cubic feet per hour = 1000 BTU**

As an example, to install a Brown Jordan FLO with a G35 burner (65,000 BTU) and located about 90 feet from the natural gas supply line with 2 elbow fittings, you would need at least a 3/4" pipe minimum.



## Lighting and Operating

### FOR YOUR SAFETY, READ BEFORE LIGHTING

**WARNING! If you do not follow these instructions exactly, a fire or explosion may result causing property damage, personal injury, and/or loss of life.**

A. This appliance can be lit electronically or with a match. When lighting, follow these instructions exactly.

B. Before lighting, smell all around the appliance area for gas. Be sure to smell next to the base of the appliance because some gas is heavier than air and will settle on the floor.

#### WHAT TO DO IF YOU SMELL GAS:

- Do not try to light any appliance.
- Do not touch any electric switch, do not use any phone nearby.
- Immediately call your gas supplier from a neighbors phone. Follow gas supplier's instructions.
- If you cannot reach your gas supplier, call the fire department.

C. Use only your hand to turn the gas control knob on propane tank (if equipped), never use tools. If the valve won't turn by hand, don't try to repair it, call a qualified service technician. Force or attempted repair may result in a fire or explosion.

D. Do not use the appliance if any part has been underwater. Immediately call a qualified service technician to inspect the appliance and replace any part which has been underwater.

E. The gas pressure regulator provided with this appliance must be used. This regulator is set for an outlet pressure of 10.5in (267mm) water column.

### Lighting Instructions

1. Depress sparker button and verify a spark is being produced between the electrode tip and receiving probe.
2. Ensure control panel valve is in the "OFF" position and slowly open valve on propane tank. If using natural gas or whole-house LP, open ball valve. If not using a control valve, skip this procedure until step 3.
3. Depress sparker button and continue holding button while turning knob to the "ON" position. Release button once flame is present.

**WARNING:** If the flame does not ignite within 5-10 seconds turn the gas "OFF" and wait for 5 minutes before re-attempting to ignite. Failure to follow this instruction may result in a volatile ignition due to the build up of vapors.

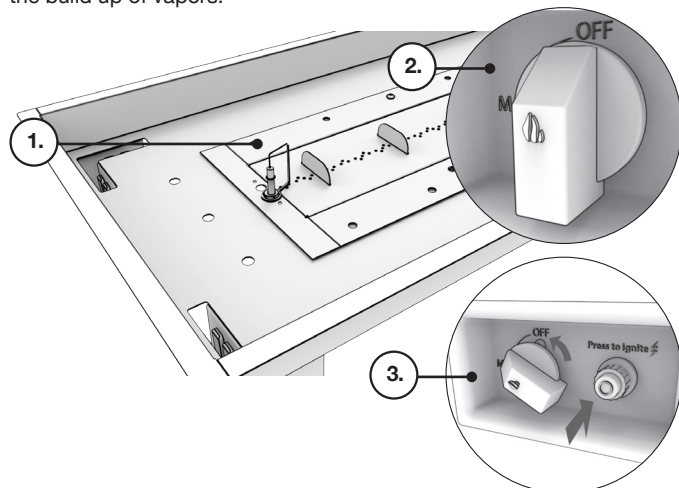

### To Extinguish

Turn control valve to "OFF" position or close ball valve. Close valve on propane tank while not in use.

**Initial break-in procedure:** When you light the appliance, you may notice that it produces heat which may have an odor. If you feel this odor is excessive it may require an initial three to four hour continuous burn on high.



#### FIRE RISK – HIGH TEMPERATURES

Keep combustible household items away from appliance.

- Do NOT obstruct combustion and ventilation air.
- Do NOT place combustible items on top of or near appliance.
- Keep furniture, draperies away from appliance.
- Do NOT use, lantern fuel, kerosene, charcoal lighter fluid, bioethanol or similar liquids in this appliance.
- Combustible materials, flammable liquids, or vapors may ignite.

## Troubleshooting - General

Symptom		Possible Causes		Corrective Actions
1.	Appliance won't light	A.	No LP in tank, or NG main not turned on.	Check the LP (propane) tank. You may be out of gas. Or check Natural Gas valve at main.
		B.	Plugged burner orifice.	Check the burner orifice for stoppage. Remove stoppage.
		C.	No spark igniting burner	Refer to ignitor on section 7 below.
2.	Low flames or won't stay lit	A.	Manual shutoff valve (on/off control knob) open or not installed between LP tank and appliance.	Close LP tank and manual shutoff valves. Open LP tank valve first, THEN the manual shutoff valve.
3.	Blue Flames	A.	This is a result of normal operation and flames will begin to yellow as unit is allowed to burn for 16-20 minutes.	No action required.
		B.	Improper air/fuel mixture related to air shutter position.	Close air shutter. (for LP, leave ¼ in [6.4mm] open, Natural gas ⅛ in [1.6mm] open).
4.	Metallic noise	A.	Noise is caused by metal expanding and contracting as it heats up and cools down, similar to the sound produced by a furnace or heating duct. This noise does not affect the operation or longevity of the appliance.	No action required.
5.	Ignitor makes clicking sound but no visible spark is produced	A.	Ignitor is improperly grounded.	Check all wire connections at back of sparker box.
		B.	Ignition or ground wire not plugged in.	Ensure ignitor wire and grounding wire are securely attached to burner.
		C.	Ignitor tip set too far from grounding probe.	Check that tip of ignitor is within ¼ in (6.4mm) of grounding probe. Gently bend ignitor tip or grounding probe by hand to achieve a smaller gap.
6.	Ignitor does not spark or make a ticking sound	A.	Battery low, Not installed, Installed incorrectly.	Ensure that a fresh AAA battery is installed Positive (+) side facing outward toward the sparker cap.
		B.	Corrosion on battery contacts.	Check contact at the bottom of the battery cavity for corrosion. Clean with a small piece of sandpaper or a file.
		C.	Battery cap not screwed down completely.	If the cap cannot be screwed down tight enough, the battery will not make a proper connection with the sparker and it will not work. Be sure to use a thin surface such as 20-22 gauge sheet metal to mount sparker in.

---

## Troubleshooting - Loud Gas Flow

---

### Excessive Rushing and Whistling noise

There are multiple causes for excess noise coming from the gas appliance. The more gas (maximum control valve setting) the more likely you are to hear excess noise. This is due to the larger volume of gas flowing at a higher velocity through the plumbing of the appliance. Gas flowing noise is inevitable so this is intended for excessively loud rushing or whistling.

#### 1. Do you hear a whistling or rushing noise in the appliance flex-line?

The internal structure of the flex-line and the path the gas follows inside of the flex-line can be the cause. When installing a flex-line, do your best to avoid sharp bends and angles.

You may be able to remedy a noisy flex-line that is already installed by carefully repositioning the line to remove sharp bends and angles.

Using commercially available appliance gas connectors (yellow corrugated flex-lines from hardware stores) are not recommended for gas fire pits or fireplaces. These hoses are not intended for the higher gas input rates of these appliances and produce large amounts of noise. There are various sizes and lengths of whistle-free flex lines available. The licensed plumber doing the installation can help recommend one.

#### 2. Is the whistling coming from the orifice?

The orifice is what controls the amount of gas that your appliance is using. Sometimes the shape of an orifice can produce a whistling depending on the gas flow rate and gas pressure.

If repositioning the flex-lines in your appliance did not fix the whistling noise, disconnect the gas supply to the burner and remove the orifice. Blow through the orifice to check for a whistle. If your orifice whistles, call our customer service at 1-888-590-3335 so we can ensure you have the specific orifice installed.

#### 3. Ensure your air shutter is properly adjusted according to the EcoSmart Gas Installation Manual.

A properly adjusted air shutter will give the brightest flame and quietest performance.

For **natural gas** the air shutter should be between 1/16" to completely closed.



For **liquid propane**, the air shutter should be open between 3/16" and 1/4".





## Service and maintenance

Although the frequency of appliance servicing and maintenance will depend on use and the type of installation, a qualified service technician should perform an appliance check-up annually.

Storage of an appliance indoors is permissible only if the cylinder is disconnected and removed from the appliance.

Stainless steel will rust or corrode over time if contamination or debris is not cleaned or removed immediately. When not in use, it is recommended that you protect your fireplace from water damage or corrosion with a protective cover.

 <b>WARNING</b> 
<p><b>Risk of injury or property damage.</b>  <b>Before servicing:</b></p> <ul style="list-style-type: none"> <li>• Turn off utilities to appliance</li> <li>• Ensure appliance is completely cooled</li> </ul>

 <b>WARNING</b> 	
    	<p>Annual inspection by qualified technician recommended.</p> <p><b>Check:</b></p> <ul style="list-style-type: none"> <li>• Obstructions of combustion and ventilation air.</li> <li>• Condition of burner assembly</li> <li>• Burner ignition and operation</li> <li>• Burner air shutter adjustment</li> <li>• Gas connections and fittings</li> </ul> <p><b>Risk of:</b></p> <ul style="list-style-type: none"> <li>• Fire</li> <li>• Delayed ignition or explosion</li> <li>• Exposure to combustion fumes</li> <li>• Odors</li> </ul>

### Maintenance and Service Tasks

Like all fire and fireplace systems, it's important to run through regular safety checks. Please take the time to familiarise yourself (and any other users) with the safety procedures associated with using your firepit.

Inspect	Maintenance Tasks	
Burner Assembly	1	Remove decorative black glass charcoal and examine burner. Vacuum and wipe out as needed. Use caution when cleaning these areas
	2	Inspect for warping and corrosion. Repair as necessary
	3	Check the hose connecting the LP gas cylinder to ensure it is not damaged. Replace as necessary.
	4	Verify air shutter area is clean
Burner Ignition and Operation	1	Verify all gas connections are tight and leak-free
	2	Clean burner top, inspect for plugged ports, corrosion, or deterioration. Replace burner if necessary.
	3	Inspect for flame problems.
	4	Verify air shutter is clear of dust and debris and is in correct position for the gas type being used.
	5	Inspect orifice for soot, dirt, or corrosion
	6	Verify manifold and inlet pressures. Adjust regulator as required.
Gas Hose with Regulator	1	The gas hose with regulator supplied with appliance must be used for LP installations. The replacement must be those specified by the appliance manufacturer

## Reference materials

### Service Parts List

Replacement Parts	SKU
<b>LP / NG BURNER</b>	
Burner Assembly EcoSmart Fire Long Gas Burner	ESF.1.SU.G35
Burner Assembly EcoSmart Fire Medium Gas Burner	ESF.1.SU.G28
Burner Assembly EcoSmart Fire Round Gas Burner	ESF.1.SU.G16
Control Key	ESF.1.P.KEY
Control Knob	ESF.1.P.KNB
Fastener Kit for Adapter Plate	ESF.1.P.FST
Flex Line (36")	ESF.1.P.F36
Gas Control Panel - Flat	ESF.1.P.CPF
Gas Control Panel - Urth	ESF.1.P.CPU
Grounding Wire (36")	ESF.1.P.G36
Igniter	ESF.1.P.IGN
LP Hose & Regulator (10')	ESF.1.P.H10
Orifice #17	ESF.1.P.017
Orifice #31	ESF.1.P.031
Orifice #38	ESF.1.P.038
Orifice #43	ESF.1.P.043
Sparker Box	ESF.1.P.GSB
Valve Components	ESF.1.P.VAL
<b>MODELS</b>	
Linear Burner Adapter Plate (G35)	ESF.1.PA35

# Warranty

## Limited One Year Warranty

MAD Design USA extends the following warranty for GB Series decorative outdoor gas fire products used in the United States of America or Canada. Dealers and employees of MAD Design USA have no authority to make any warranty or authorize any remedies in addition to or inconsistent with the terms of this warranty. This warranty gives you specific legal rights. You may also have other rights that vary from state to state.

MAD Design USA warrants that this GB Series decorative gas appliance (the "product") will be free from defects in material and workmanship for a period of one year from its date of purchase. Stainless steel parts and assemblies carry a limited lifetime warranty. This warranty is subject to the conditions, exclusions and limitations described below.

This warranty applies only to the original owner of the Product and is non-transferable. MAD Design USA obligation under this warranty does not extend to damages resulting from (1) assembly, operation or maintenance of the Product not in accordance with the Installation/ Assembly Instructions, Operating Instructions and the Listing Agency Identification Label furnished with the Product; (2) installation or use which does not comply with local building codes and ordinances; (3) shipping, improper handling, improper operation, abuse, misuse, accident or unworkmanlike repairs; (4) use of fuels other than those specified in the Operating Instructions; (5) Installation or use of components not supplied with the Product or any other components not expressly authorized and approved in writing by MAD Design USA; and/ or (6) modification of the Product not expressly authorized and approved in writing by MAD Design USA. Any of the circumstances described in the previous sentence voids this warranty. This warranty is void if the Product or any component has been removed, repaired, or replaced before MAD Design USA has been afforded a reasonable opportunity to inspect the Product.

The Warranties set out above are express Warranties given by MAD Design USA and are in addition to the rights and remedies which are conferred upon consumers by Trade Practices Act 1974 of the Commonwealth and other Commonwealth, State or Territory legislation.

**Service under the warranties set out above must be provided by MAD Design USA Authorised Customer Service Centre which shall provide service during their normal working hours.**

**This warranty certificate along with proof of date of purchase must be produced when making any claim.**

FIRST NAME \_\_\_\_\_

LAST NAME \_\_\_\_\_

EMAIL \_\_\_\_\_

ADDRESS \_\_\_\_\_

CITY \_\_\_\_\_ STATE \_\_\_\_\_ ZIP \_\_\_\_\_

COUNTRY \_\_\_\_\_

This warranty is limited to the replacement or repair of defective components or workmanship and MAD Design USA may fully discharge its obligations under this warranty by repairing or replacing, at its discretion, the defective components. MAD Design USA will provide replacement parts at no charge and will pay reasonable freight costs related to replacing or repairing defective components under this warranty. The maximum amount recoverable under this warranty is limited to the purchase price of the Product and, if MAD Design USA is unable to provide replacement or repair in an expedient and cost-effective manner, MAD Design USA may discharge all obligations under this warranty by refunding the purchase price of the Product.

EXCEPT TO THE EXTENT PROVIDED BY LAW, MAD DESIGN USA MAKES NO EXPRESS WARRANTIES OTHER THAN THE WARRANTY EXPRESSED HEREIN. THE DURATION OF ANY IMPLIED WARRANTY IS LIMITED TO THE DURATION OF THE WARRANTY SPECIFIED ABOVE. IN NO EVENT SHALL MAD DESIGN USA BE LIABLE FOR ANY INCIDENTAL OR CONSEQUENTIAL DAMAGES CAUSED BY DEFECTS IN THE PRODUCT. Some states do not allow limitations on how long an implied warranty lasts, or do not allow exclusion or limitation of incidental or consequential damages, so these limitations may not apply to you.

**To obtain service under this warranty, you must:**

1. Send written notice of the claimed condition to:  
5875 Green Valley Circle, Suite 100, Culver City CA 90230
2. Affirm that you are the original owner of the Product.
3. Photos or video of issue will be required in order to assess the warranty claim.
4. Provide MAD Design USA reasonable opportunity to investigate the claim, including reasonable opportunity to inspect the Product prior to any repair or replacement work and before the Product or any component of the Product has been removed.

DATE OF PURCHASE \_\_\_\_\_

PURCHASED FROM \_\_\_\_\_

PRIMARY USE \_\_\_\_\_

MODEL NAME \_\_\_\_\_

SERIAL NUMBER \_\_\_\_\_

*You will find this on the dataplate on the side of the burner.*

For warranty claims please contact your local distributor. If there is not a local distributor in your country please visit [www.ecosmartfire.com](http://www.ecosmartfire.com) to source the details of the country closest to you.

\*Do not return this form to MAD Design USA, please retain for your own reference.





**MAD Design USA**

5875 Green Valley Circle, Suite 100

Culver City CA 90230

T + 1 (888) 590.3335 E [info@mad-usa.com](mailto:info@mad-usa.com)

V0719

This product is distributed by EcoSmart Inc  
DBA MAD Design USA.

---