



42, 54 & 72 ProBuilder GSB2 Owner's Manual



WARNING: FIRE OR EXPLOSION HAZARD

Failure to follow safety warnings exactly could result in serious injury, death, or property damage.

- Do not store or use gasoline or other flammable vapors and liquids in the vicinity of this or any other appliance.
- **WHAT TO DO IF YOU SMELL GAS**
 - Do not try to light any appliance.
 - Do not touch any electrical switch; do not use any phone in your building.
 - Leave the building immediately
 - Immediately call your gas supplier from a neighbor's phone. Follow the gas supplier's instructions.
 - If you cannot reach your gas supplier, call the fire department.
- Installation and service must be performed by a qualified installer, service agency or the gas supplier.



**HOT GLASS WILL CAUSE
BURNS**

**DO NOT TOUCH GLASS
UNTIL COOLED**

**NEVER ALLOW CHILDREN
TO TOUCH GLASS**

A barrier designed to reduce the risk of burns from the hot viewing glass is provided with this appliance and shall be installed for the protection of children and other at-risk individuals.

Tested and Listed by



(42 GSB2) Report # 0028GF105S
54 GSB2) Report # 0028GF105S REV002
(72 GSB2) Report # 0028GF105S-001

Omni-Test Laboratories, Inc.
Portland, Oregon
ANSI Z21.88-2016
CSA 2.33-2016

- Operation
- Maintenance

This appliance may be installed in an aftermarket, permanently located, manufactured home (USA only) or mobile home, where not prohibited by local codes. This appliance is only for use with the type of gas indicated on the rating plate. A conversion kit is supplied with the appliance.

INSTALLER: Leave this manual with the appliance.

CONSUMER: Retain this manual for future reference.

Introduction

We welcome you as a new owner of a ProBuilder GSB2 gas fireplace. This manual details operation and maintenance of this fireplace. Please familiarize yourself with the Owner's Manual before operating your heater and save the manual for future reference.

Important Information

<p>No other ProBuilder gas fireplace has the same serial number as yours. The serial number is on the listing label that is chained to the gas control valve. This serial number may be needed in case you require service.</p> <p>Model: 42 ProBuilder GSB2 54 ProBuilder GSB2 <u>72 ProBuilder GSB2</u></p> <p>Serial Number: _____</p> <p>Purchase Date: _____</p> <p>Purchased From: _____ _____ _____</p>	<p>Register your warranty online at:</p> <div style="border: 1px solid black; padding: 2px; display: inline-block; margin: 5px 0;">traviswarranty.com</div> <p>Save Your Bill of Sale.</p> <p>To receive full warranty coverage, you will need to show evidence of the date you purchased your heater.</p> <p>We suggest that you attach your Bill of Sale to this page so that you will have all the information you need in one place should the need for service or information occur.</p>
--	---

Installation Warnings

- **Installation requirements are printed in the ProBuilder GSB2 Installation Manual. All requirements in the installation manual must be met.**
- **Failure to follow all of the requirements may result in property damage, bodily injury, or even death.**
- **This heater must be installed by a qualified installer who has gone through a training program for the installation of direct vent gas appliances.**
- **This appliance must be installed in accordance with all local codes, if any; if not, follow ANSI Z223.1 and NFPA 54(88). In Australia follow AS/NZS 5601.1.**
- **In Manufactured or Mobile Homes must conform with Manufactured Home Construction and Safety Standard, Title 24 CFR, Part 3280, or, when such a standard is not applicable, the Standard for Manufactured Home Installations, ANSI/NCSCS A225.1. This appliance may be installed in Manufactured Housing only after the home is site located.**
- **The fireplace is designed to operate on natural gas, or propane (LP).**
- **All exhaust gases must be vented outside the structure of the living-area. Combustion air is drawn from outside the living-area structure.**
- **Notify your insurance company before hooking up this fireplace.**

Table of Contents

Introduction	2	Normal Operating Odors	10
Important Information	2	Power Outages	10
Installation Warnings	2	Glass Frame Removal and Installation	11
Table of Contents	3	Crushed Glass Installation	14
Features	3	Maintaining Your Heater's Appearance	16
Heating Specifications	3	Cleaning The Glass	16
Before You Begin	6	Cleaning the Fireplace	16
Location of Controls	6	Yearly Service Procedure	17
Starting the Fireplace for the First Time	7	Troubleshooting Table	18
Turning the Fireplace On and Off	7	Replacement Parts List	19
Adjusting the Flame Height	7	Wiring Diagram	20
Adjusting the Blower Speed (Optional)	8	42 ProBuilder Safety Label	21
Continuous Pilot / GreenSmart™ Pilot Switch	8	54 ProBuilder Safety Label	22
Pilot Fuel Conservation Timer	9	72 ProBuilder Safety Label	23
Starting the Heater for the First Time	10	CONDITIONS & EXCLUSIONS	24
Adjusting the Blower Speed (Optional)	10	IF WARRANTY SERVICE IS NEEDED:	24
		Index	26

Features

- Works During Power Outages
- Contemporary Look
- Optional Blower for Heat Distribution
- Optional Remote Thermostat
- Standing Pilot
- Standing or Intermittent (GreenSmart) Pilot
- Variable-Rate Heat Output
- Low Maintenance

Heating Specifications

		Natural Gas	Propane
42 ProBuilder	Approximate Heating Capacity (in square feet)*	Up to 1,250	Up to 1,250
	Maximum BTU Input Per Hour	25,000	25,000
54 ProBuilder	Approximate Heating Capacity (in square feet)*	1,650	1,650
	Maximum BTU Input Per Hour	33,000	33,000
72 ProBuilder	Approximate Heating Capacity (in square feet)*	2,250	2,250
	Maximum BTU Input Per Hour	45,000	45,000

* Heating capacity will vary with floor plan, insulation, and outside temperature.

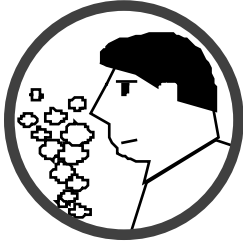
**IF YOU SMELL GAS:**

- * Do not light any appliance
- * Extinguish any open flame
- * Do not touch any electrical switch or plug or unplug anything
- * Open windows and vacate building
- * Call gas supplier from neighbor's house, if not reached, call fire department



This unit must be installed by a qualified installer to prevent the possibility of an explosion. Your dealer will know the requirements in your area and can inform you of those people considered qualified. The room heater should be inspected and cleaned before use and at least annually by a qualified service person. More frequent cleaning may be required due to excessive lint from carpeting, bedding material, etc.

The instructions in this manual must be strictly adhered to. Do not use makeshift methods or compromise in the installation. Improper installation will void the warranty and safety listing.

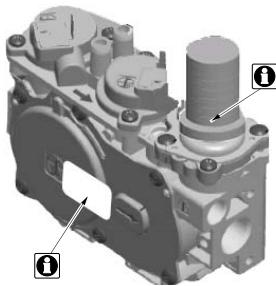

This heater is either approved for natural gas (NG) or for propane (LP). Burning the incorrect fuel will void the warranty and safety listing and may cause an extreme safety hazard. Direct questions about the type of fuel used to your dealer. Check for a label on the flame adjust knob on the gas control valve (this is the best place to check). You may also check for a label on the gas control valve body.



Contact your local building officials to obtain a permit and information on any installation restrictions or inspection requirements in your area. Notify your insurance company of this heater as well.



If the flame becomes sooty, dark orange in color, or extremely tall, do not operate the heater. Call your dealer and arrange for proper servicing.



It is imperative that control compartments, screens, or circulating air passageways of the heater be kept clean and free of obstructions. These areas provide the air necessary for safe operation.



Do not operate the heater if it is not operating properly in any fashion or if you are uncertain. Call your dealer for a full explanation of your heater and what to expect.



Do not store or use gasoline or other flammable liquids in the vicinity of this heater.



Do not operate if any portion of the heater was submerged in water or if any corrosion occurs. Immediately call a qualified service technician to inspect the appliance and to replace any part of the control system and any gas control that has been under water.



Do not place clothing or other flammable items on or near the heater. Because this heater can be controlled by a thermostat there is a possibility of the heater turning on and igniting any items placed on or near it.

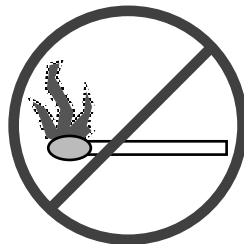

Light the heater using the built-in igniter. Do not use matches or any other external device to light your heater.

Allow the heater to cool before carrying out any maintenance or cleaning.



The viewing glass should be opened only for conducting service. Do not operate with cracked, broken, or removed glass.

Any safety screen or guard removed for servicing must be replaced prior to operating the heater.

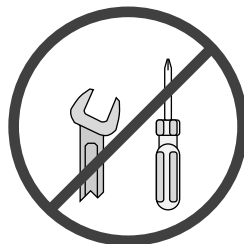

Never remove, replace, modify or substitute any part of the heater unless instructions are given in this manual. All other work must be done by a trained technician. Don't modify or replace orifices.



Operate the heater according to the instructions included in this manual.

If the main burners do not start correctly turn the gas off at the gas control valve and call your dealer for service.

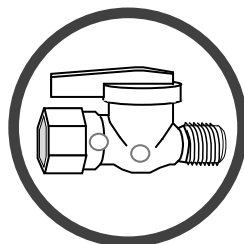

Instruct everyone in the house how to shut gas off to the appliance and at the gas main shutoff valve. The gas main shutoff valve is usually next to the gas meter or propane tank and requires a wrench to shut off.



This unit is not for use with solid fuel

Do not place anything inside the firebox (except the crushed glass).

If any component becomes damaged, replace with Travis Industries components.



Do not throw this manual away. This manual has important operating and maintenance instructions that you will need at a later time. Always follow the instructions in this manual.



Children and adults should be alerted to the hazards of high surface temperature and should stay away to avoid burns or clothing ignition. Young children should be supervised when they are in the same room as the heater.



Travis Industries, Inc. grants no warranty, implied or stated, for the installation or maintenance of your heater, and assumes no responsibility of any consequential damage(s).

Before You Begin

- Read this entire manual before you use your new fireplace (especially the section "Safety Precautions" on pages 4 & 5). Failure to follow the instructions may result in property damage, bodily injury, or even death.

Location of Controls

There is a door on the lower portion of the screen assembly to provide access to the manual controls on the fireplace. The door is held closed by two magnets. Open the door by gently pulling outward on the upper portion of the lower trim.

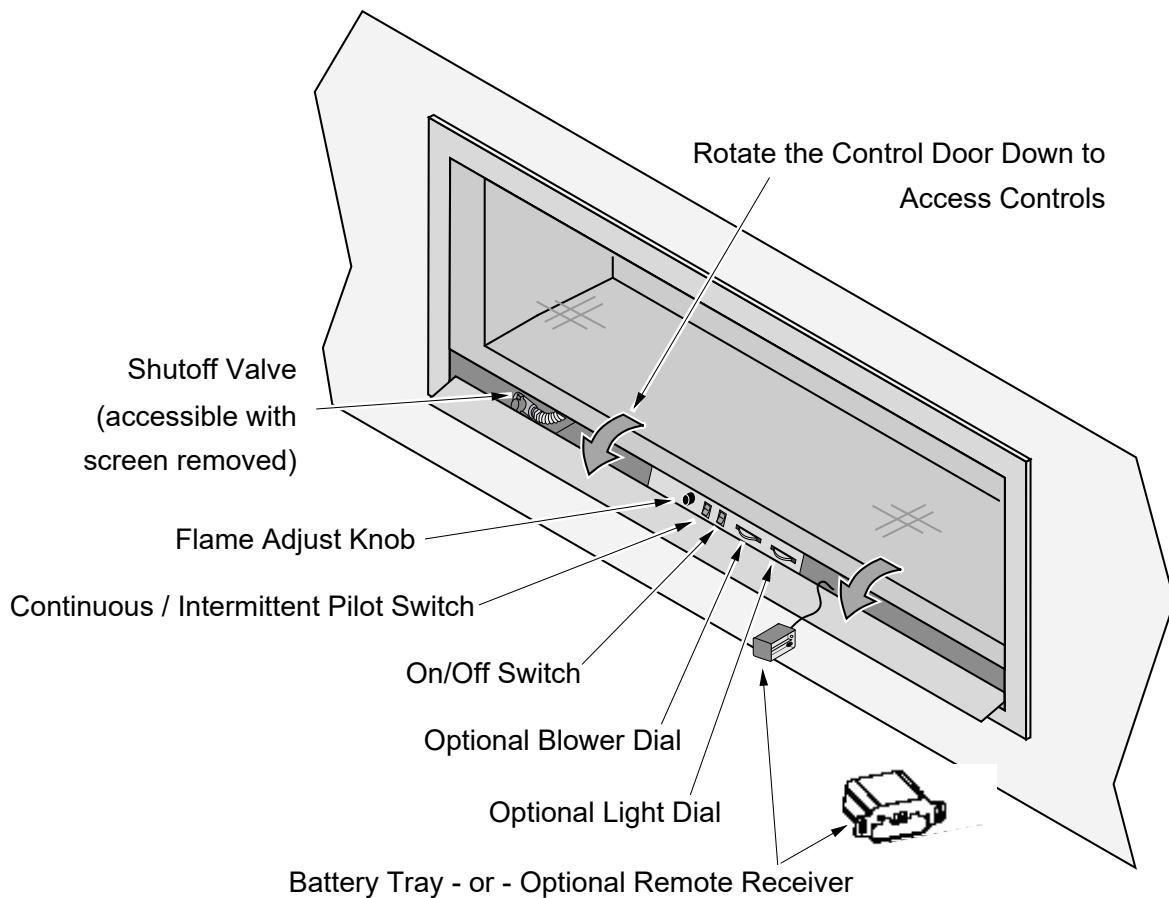

On/Off Switch

This control is used to turn the heater on and off.

Gas Control Knob

This knob is used to control gas to the heater and for starting the pilot. There are three positions, ON, OFF, & PILOT. The pointer to the left of the knob indicates the position this knob is in.

Flame Adjust Knob

This knob controls the flame height from low ("LO") to high ("HI"). The pointer above the knob points to the position this knob is in.

Continuous Pilot -- GreenSmart Pilot

This switch controls how the pilot flame works. See the section "Continuous Pilot / GreenSmart Pilot" for details.

Optional Remote Receiver

The receiver is used in conjunction with the optional remote thermostat. It is used to control the remote and replaces the on/off switch for direct operation.

Optional Blower Dial

This knob controls the speed of the internal convection blower that pushes the heated air into the room.

Optional Light Dial

This dial controls the brightness of the optional accent lights (if applicable).

Starting the Fireplace for the First Time

- Burn the heater at a high setting with the blower off for an extended period (up to 48 hours). This will cure the painted surfaces. **Fumes** from the paint curing and oil burning off the steel will occur. This is normal. We recommend opening a window to vent the room.
- **Condensation** may appear on the glass each time you start the fireplace - this is normal.
- **Blue Flames** will occur on the fireplace when it first comes on. After fifteen minutes the flames will turn a more realistic yellow and orange color.
- Certain installations use a remote, thermostat, or wall switch to turn the fireplace on and off. If this is the case, leave the ON/OFF switch "ON".
- Verify the power backup and control light batteries are installed.

Turning the Fireplace On and Off



ON/OFF SWITCH

Use this switch to turn the main burner on and off manually.

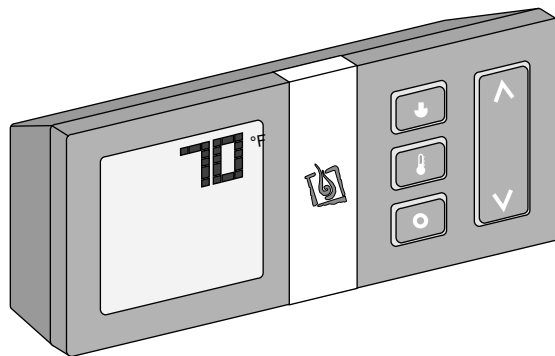

OPTIONAL REMOTE THERMOSTAT

See the instructions included with the remote for details on operation.

- Do not place any combustible items on top of or directly in front of the heater, even temporarily. The optional thermostat may start the heater causing a combustible item to ignite.
- If the heater turns on and off frequently while using the thermostat, you may want to adjust the flame height down until it produces just enough heat needed.

Adjusting the Flame Height

This fireplace has an adjustable flame to tailor the look and heat output to your specific needs. It is adjusted by turning the flame adjust knob.

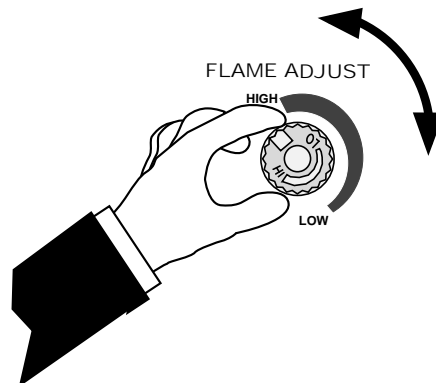

Adjusting the Blower Speed (Optional)

The optional blower helps transfer heat from the heater into the room. It will not turn on until the heater is up to temperature (approximately 10 minutes after starting). See the illustration below for instructions on adjusting the blower speed.

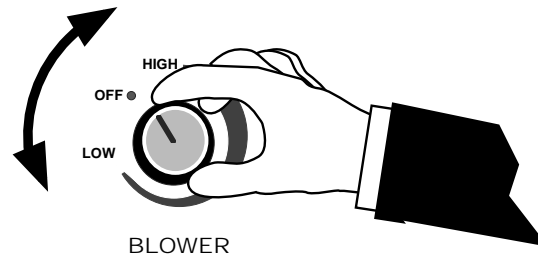

Continuous Pilot / GreenSmart™ Pilot Switch

This fireplace may run with the pilot continuously running or in GreenSmart (intermittent) mode. For most homeowners, the GreenSmart mode is preferred (this saves fuel, doesn't give off un-needed heat). However, in some situations the homeowner may prefer to switch the fireplace to continuous pilot. The most typical reasons for switching to continuous pilot are:

- Very Cold Conditions – in very cold conditions you may notice that the burner does not light quickly, and the flames lift off the burner. If this is situation, we recommend you switch to continuous pilot. This will create a slight draft in the vent, allowing for the burner to light quickly and draft correctly.
- Excessive Condensation on Glass after Startup – certain installations may encounter excessive fogging on the window after startup (not just the first time the fireplace was started). This is an aesthetic condition that may be remedied by switching the fireplace to continuous pilot.
- Cold Glass or Fireplace Front – in very cold conditions you may notice that the fireplace front and glass become very cold. To remedy this, switch the fireplace to continuous pilot.
- Frequent On / Off Operation – if you are frequently turning the fireplace on and off, you may wish to leave it in continuous pilot. This allows the burner to turn on more quickly, without pilot ignition delay.

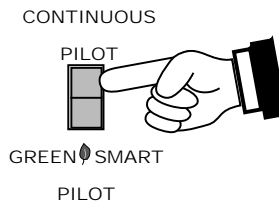

Pilot Fuel Conservation Timer

7 Day Pilot Shutoff Timer (applies to units in CPI mode only)

This appliance may be equipped with a 7 day pilot shutoff timer. This timer helps conserve fuel and save money by turning the pilot off when the appliance is not used for 7 days (this timer is mandated in certain areas for conservation purposes). This applies only when the unit is in CPI (Continuous Pilot Ignition) mode. If the unit is in IPI (Intermittent Pilot Ignition) mode, the timer does not apply.

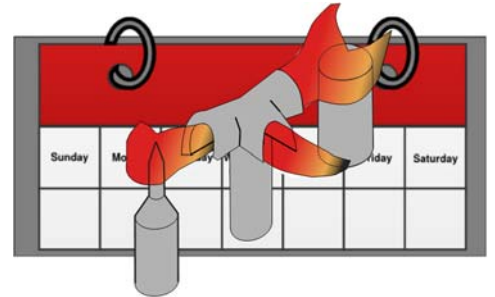

When in CPI mode the pilot will remain lit as long as the burner is engaged within a 7 day window. Each time the burner is turned on the 7 day timer resets. If the burner is not engaged within the 7 day window, the pilot will automatically revert to IPI mode and turn off to conserve fuel.

To switch back to CPI, simply:

GSB2 Units: toggle the IPI/CPI switch to IPI, then back to CPI.

GSR2 Units: use the remote to toggle from IPI mode, then back to CPI mode.

To prevent the need to reset the pilot mode during the heating season, we have listed a few strategies below:

Option 1: Remember to periodically turn on the heater during the heating season

If you use your heater for supplemental heat, this may be the best solution. Set a specific time, once or twice per week (e.g. 5pm on Tuesday & Friday) to turn the heater on for a few minutes. This will reset the timer and prevent the need to restart the pilot.

Option 2: Use a thermostat

GSR Units: Use the thermostat included with the appliance

GSB Units: Consult your dealer for thermostats compatible with your appliance.

The use of a thermostat will keep the room at a constant temperature and will, in most cases, keep the heater working throughout the heating season. Light the pilot at the beginning of the heating season and set the thermostat to the desired room temperature. As long as the outside temperature does not rise excessively, for seven days or more, the pilot will continue to operate.

Option 3: Use a programmable thermostat (GSB2 Only)

A programmable thermostat may be set to turn on, once per week, to a high temperature for a short time. This will reset the 7-day timer and allow the heater to operate without having to restart the pilot.

Adjusting the Blower Speed (Optional)

The optional blower helps transfer heat from the heater into the room. It will not turn on until the heater is up to temperature (approximately 10 minutes after starting). See page 7 for details on adjusting the blower speed.

Normal Operating Odors

This appliance has several areas that reach high temperatures. Dust or other particles on these areas may burn and create an odor. This is normal during start-up. You may notice the smell is more acute if the appliance was left idle for a long period.

Power Outages

Four AA batteries are used as a power backup for the fireplace in case the household (AC) power goes out. These batteries must be inserted into battery holder (or remove receiver is using the optional GS thermostatic remote). The fireplace controller will beep once these batteries start to go dead. Replace batteries before each heating season to insure proper operation.

Glass Frame Removal and Installation



A barrier designed to reduce the risk of burns from the hot viewing glass is provided with this appliance and shall be installed for the protection of children and other at-risk individuals.



If the barrier becomes damaged, the barrier shall be replaced with the manufacturer's barrier for this appliance.



The appliance must be completely cool before removing the glass.



Do not strike or slam the glass.



Warning: Do not operate appliance with the glass front removed, cracked or broken. Replacement of the glass should be done by a licensed or qualified service person.

- Remove the screen-trim assembly by lifting the assembly up slightly and tilting it toward you. The mounting hooks on the back of the assembly will disengage the fireplace. Set the assembly aside for reinstallation.

NOTE: Opening the access door on the front of the assembly allows for an easy location to get a secure grip on the assembly for removal

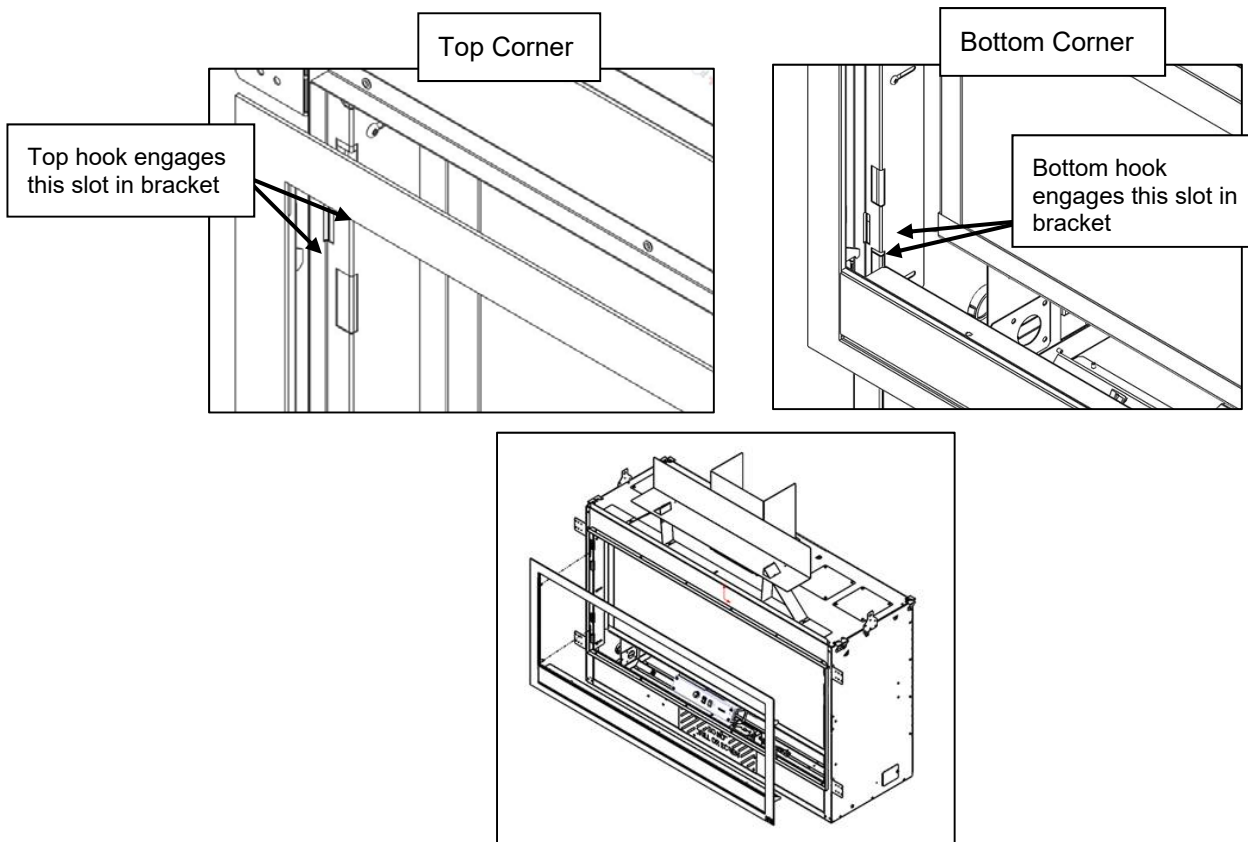

	Replacement Barrier Part #
42 ProBuilder	250-04494
54 ProBuilder	250-04690
72 ProBuilder	250-04655

- Remove the glass frame following the directions below.

a Open the latches holding the glass frame in place (start with the bottom) - follow the directions shown to the right.

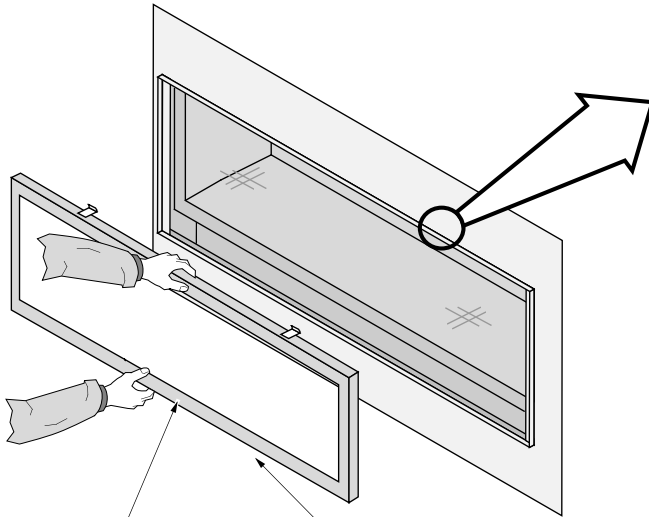

b Lift the glass frame up and pull it forward to remove.

NOTE:
You may need to lift the glass frame while re-attaching.

Re-Attaching the Glass Frame:

- Hang the glass frame on the firebox.
- While holding in place, attach the upper latches (follow the instructions to the right in reverse).
- Lift the glass frame slightly and attach the lower latches.

NOTE: Make sure the glass frame is all the way in place - it should be parallel with the front of the fireplace when installed.

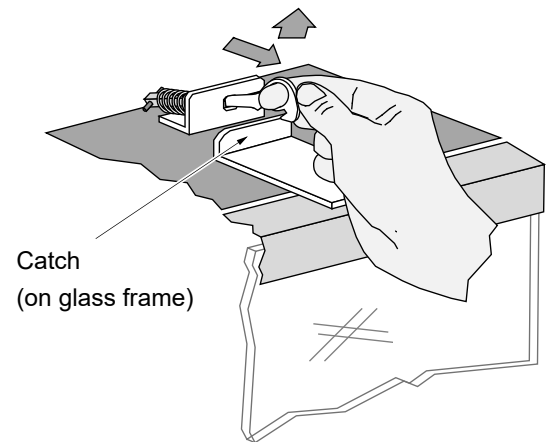
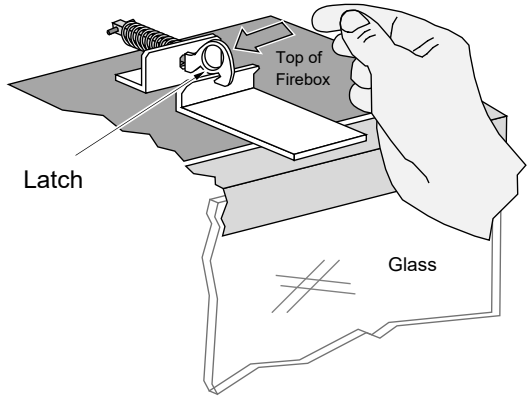
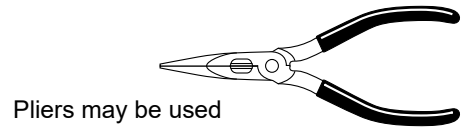

	Replacement Glass Frame Part #
42 ProBuilder	250-04491
54 ProBuilder	250-04689
72 ProBuilder	250-04654

The latch can come loose from glass frame anchor. This occurs when it is turned 1/4 turn when it is disengaged. Follow the directions below to re-install the latch if it becomes loose.

Hold the latch at an angle and insert it into the slot on the glass frame anchor.

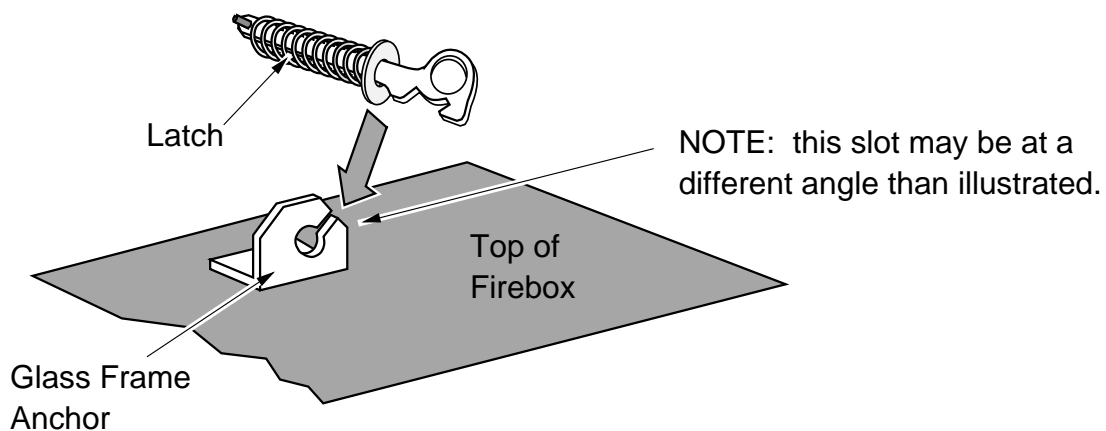

Note how the washer on the latch fits behind the flange on the glass frame anchor.

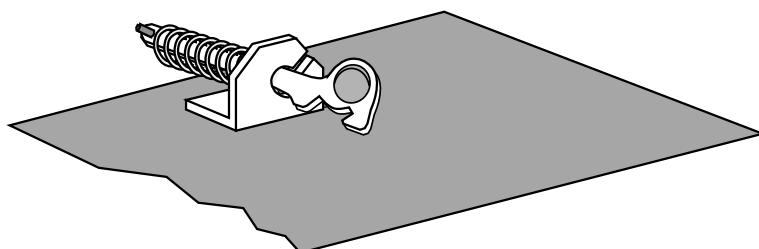

Once fully inserted, turn the latch until it is upright.

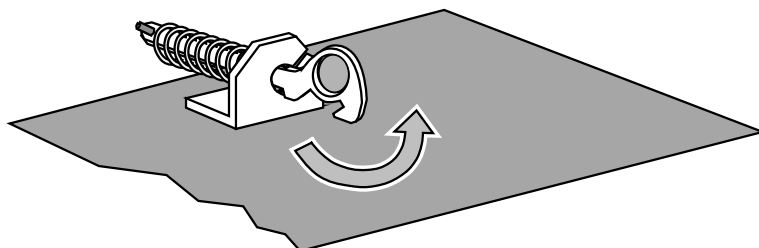

Crushed Glass Installation

Do not allow the crushed glass to block the air slots or to become too thick (maximum 1 layer deep on burner). Failure to properly install glass may lead to sooting and improper burning.



If converting to LP (propane), convert the appliance prior to placing the crushed glass.

Install the crushed glass on the glass tray following the directions below.

	Quantity of Crushed Glass
42 ProBuilder	5 lbs. (2.3 Kg)
54 ProBuilder	6 lbs. (2.7 Kg)
72 ProBuilder	8 lbs. (3.6 Kg)

- 1 Remove the setup pilot cover and the cover plate from the unit to access the pilot assembly underneath. Remove the silicone sleeve that is shipped on the spark electrode. Re-install the cover plate and setup pilot cover. Make sure that the setup pilot cover is installed over the pilot assembly before adding glass.



- 2 Spread an even layer of crushed glass over the media tray and burner. The glass must be only 1 layer thick on the burner but can be 2 layers thick on the media tray. **Make sure no glass is in the pilot area** indicated in the picture below.

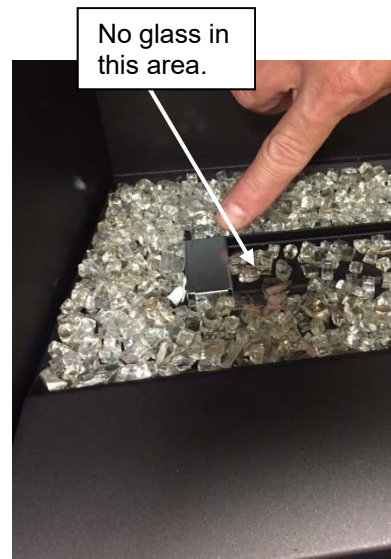

- 3 Make sure the rear and end air channels are free of crushed glass. Use a screwdriver to clear this area.

Make sure the glass is only 1 layer deep on the burner.



- 4 Remove the pilot shield to uncover the pilot once you are finished placing the glass.



Maintaining Your Heater's Appearance



The appliance must be completely cool prior to conducting service.

Cleaning The Glass

The glass may be cleaned with a non-abrasive cleaner. To clean the inside of the glass, simply remove the glass frame, place it on a non-scratching surface, and clean the surface.

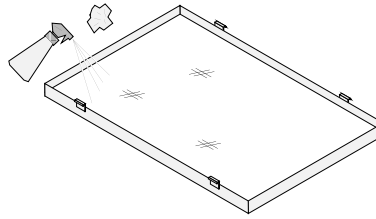

Cleaning the Fireplace

Use a duster to remove dust from the visible portions of the fireplace. Contact your dealer if you wish to re-paint any surfaces. Heat-resistant stove-paint (with instructions) is available from your dealer.

Yearly Service Procedure

WARNING: Failure to inspect and maintain the stove may lead to improper combustion and a potentially dangerous situation. We recommend the following procedures be done by a qualified technician.

- Shut off gas to the fireplace and let it cool for 15 minutes. Remove the glass. Inspect and operate the pressure relief mechanism to verify relief mechanisms are free from obstruction to operate.
- Clean glass window with a suitable fireplace glass cleaner. Abrasive cleaners must not be used. Be careful not to scratch the glass when cleaning.
- Vacuum and clean any debris in the firebox.
- Check all accessible gas-carrying tubes, connections, pipes and other components for leaks.
- Inspect the burner and firebox. Make sure the burner is not warped, cracked, or damaged. Check the firebox and area around the pilot to make sure there is no damage. Inspect primary air openings for blockage. If any problem is found, discontinue use and contact your dealer for service.
- Inspect the area behind the access door; clean if necessary. Check the gas control valve and the gas lines. If damage is found, discontinue use and contact your dealer for service. Clean the air channels, ducts, and blower (if applicable)
- Inspect vent and vent termination for sooting, obstructions, or damage. Make repairs as needed. Remove any debris or vegetation near the vent termination. Contact your dealer if any sooting or deterioration is found near the vent termination.
- Reinstall the glass assembly. If the glass is damaged, replace. Make sure the gasket along the perimeter of the glass contacts the face of the firebox and forms an air-tight seal. If it does not, re-align or replace the gasket to insure an air-tight seal.
- Turn the pilot flame on (continuous pilot). It should touch approximately 3/8" of the top of the flame sensor (see below). If it does not, contact your dealer.

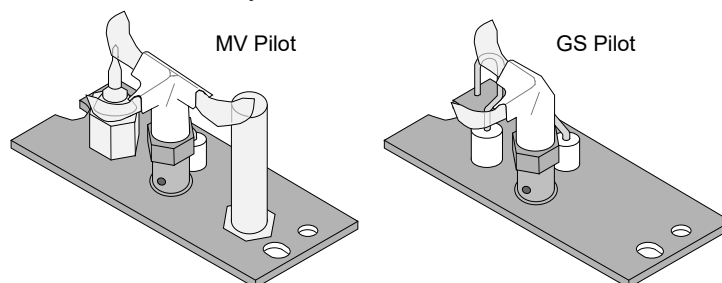

- Start the main burner. Inspect and ensure the lighting of the main burner occurs within 4 seconds of the main gas valve opening.
- Test the flame failure response time of the flame safety system. It must de-energize the safety shutoff in no more than 30 seconds.
- After 15 minutes the flames should be orange/yellow and not touch the top of the firebox. If the pilot or main burners do not burn correctly, contact your dealer for service. Monitor blower operation

Troubleshooting Table

Problem:	Possible Cause:	Don't Call for Service Until You:
Pilot Will Not Light	A gas shut off valve is turned off..... The gas control knob isn't turned to "PILOT"..... The valve control knob isn't pushed in..... The igniter wasn't pressed repeatedly..... No Propane in Tank.....	Check all gas shut off valves See "Starting the Pilot Light" Step C See "Starting the Pilot Light" Step C See "Starting the Pilot Light" Step C Check Tank Level
Main Burners Will Not Start	The pilot light has gone out..... The gas control valve is turned to "PILOT" or "OFF" The ON/OFF switch is turned to "OFF"..... The remote control is not working correctly..... The thermostat is disconnected or set too low.....	See "Starting the Pilot Light" See "Starting the Pilot Light" Turn the ON/OFF switch to "ON" See the remote control instructions See "Thermostat Operation"
Optional Remote Control Does Not Work	The pilot light has gone out..... The gas control valve is turned to "PILOT" or "OFF" The ON/OFF switch is turned to "OFF"..... The remote is too far away from the heater..... The remote control receiver is turned "Off"..... Remote or receiver batteries are dead.....	See "Starting the Pilot Light" See "Starting the Pilot Light" Turn the ON/OFF switch to "ON" Use the remote closer to the heater See the remote control instructions See the remote control instructions
Heater Will Not Distribute Heat	The heater is not up to temperature.....	This is normal – allow 5 to 20 minutes for heater to reach operating temperature.
Optional Blower Does Not Turn On	The heater is not up to temperature..... The heater is not getting electricity..... The blower is set to off.....	The blower will turn on once the heater is up to temperature (5 to 20 minutes). Check the breaker switch. Check the blower knob.
Pilot Goes Out Intermittently	The gas supply has been shut off.....	Keep the gas supply turned on
Flames Are Too Blue	The heater has just been started..... Improper air shutter adjustment.....	This is normal - see "Starting the Heater for the First Time" Adjust Air Shutter - contact your dealer
Flames Are Too Short (Under 6")	The flame height may be turned too low.....	Turn the flame height to "HI" - See "Adjusting the Flame Height"
Thin Layer of Soot Covers the Glass	The logs or coals are placed incorrectly..... Improper air shutter adjustment.....	See "Log Set Installation" Adjust Air Shutter - contact your dealer

Replacement Parts List

Caution: Use only Travis Industries replacement parts. Do not use substitute materials.

Warning: Do not operate appliance with the glass front removed, cracked, or broken. Replacement of the glass should be done by a licensed or qualified service person.

GLASS w/FRAME (42 ProBuilder)	250-04491
GLASS w/FRAME (54 ProBuilder)	250-04689
GLASS w/FRAME (72 ProBuilder)	250-04654
SCREEN BARRIER, FRONT (42 ProBuilder)	250-04494
SCREEN BARRIER, FRONT (54 ProBuilder)	250-04690
SCREEN BARRIER, FRONT (72 ProBuilder)	250-04655
PILOT ASS'Y, 2-WAY PSE	250-04480
VALVE, NG w/MANUAL H/L	250-04398
VALVE REGULATOR, LP MAN HI-LO	250-01427

Contact your local Travis Industries Dealer to purchase replacement parts

Wiring Diagram

Caution: Label all wires prior to disconnection when servicing controls. Wiring errors can cause improper and dangerous operation.

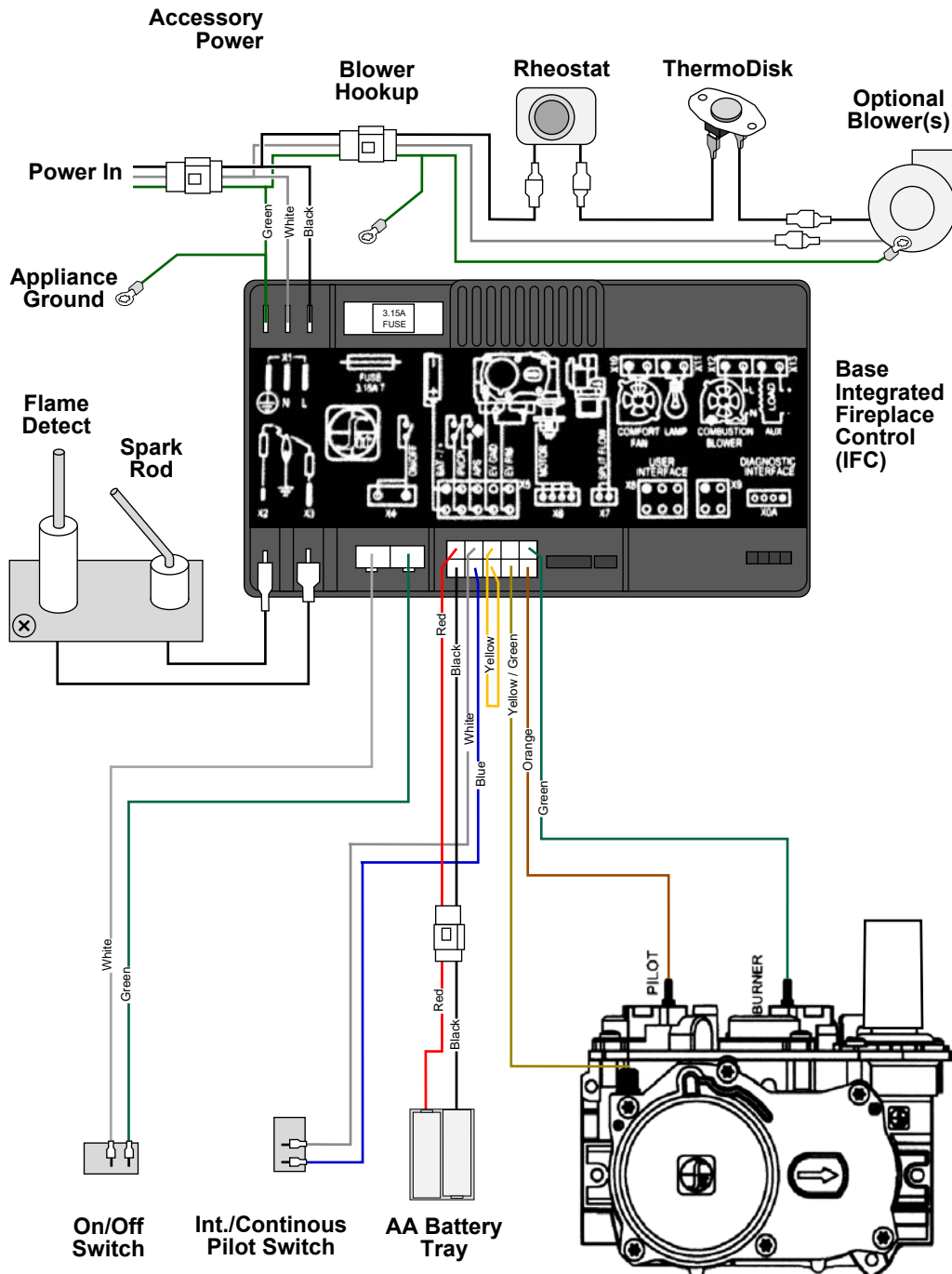

42 ProBuilder Safety Label

The safety (listing) label is attached to the operating tag (chained to the heater near the gas control valve). A copy is shown below

<p>Minimum Clearances to Combustibles</p> <p>Fireplace to Adjacent Wall 0" (0mm) Wood Floor Beneath Fireplace 0" (0mm) Back to Enclosure 0.5" (13mm)</p> <p>Base Of Fireplace To Enclosure Top 45.25" (1150mm) Sides To Enclosure 0.5" (13mm) Base Of Fireplace To A Mantel See Owner's Manual</p>	<p>FAN TYPE VENTED CIRCULATOR (OPTIONAL)</p> <p>Blower Electrical Rating: 120 VAC, 4.5 Amps, 60 Hz, 540 Watts (Part No. 250-04395) fan or blower assembly may be used. For use only with factory barrier (see "Glass Frame Removal" in the installation manual for part numbers). Follow installation instructions.</p> <table border="1"> <thead> <tr> <th>L.P.</th> <th>N.G.</th> <th>L.P.</th> <th>N.G.</th> </tr> </thead> <tbody> <tr> <td>Input Rate on "HI" (BTU/Hr) 25,000</td> <td>13,000</td> <td>Minimum Inlet Pressure (inches W.C.) 11"</td> <td>5.5"</td> </tr> <tr> <td>Input Rate on "LO" (BTU/Hr) 1,450mm</td> <td>#42</td> <td>Maximum Inlet Pressure (inches W.C.) 13"</td> <td>7"</td> </tr> <tr> <td>Orifice Size - (DMS)</td> <td></td> <td>Manifold Pressure on "HI" (inches W.C.) 11"</td> <td>3.8"</td> </tr> </tbody> </table> <p>This appliance is equipped for use only at altitudes 0-2,000 feet (0-610m) in the USA. In Canada, 0-4,500 feet (0-1370m). For altitudes above 2,000 feet, the vent configuration, orifice, or combination of both may be need to be changed. See owner's manual for information on making these changes.</p>	L.P.	N.G.	L.P.	N.G.	Input Rate on "HI" (BTU/Hr) 25,000	13,000	Minimum Inlet Pressure (inches W.C.) 11"	5.5"	Input Rate on "LO" (BTU/Hr) 1,450mm	#42	Maximum Inlet Pressure (inches W.C.) 13"	7"	Orifice Size - (DMS)		Manifold Pressure on "HI" (inches W.C.) 11"	3.8"	<p>Manufactured by:</p>  <p>TRAVIS INDUSTRIES HOUSE OF FIRE 12821 Harbour Reach Drive Houston, Texas 77044 www.travisproducts.com</p> <p>MANUFACTURE DATE:</p> <table border="0"> <tr> <td><input type="checkbox"/> 2017</td> <td><input type="checkbox"/> Jan.</td> <td><input type="checkbox"/> Apr.</td> <td><input type="checkbox"/> Jul.</td> <td><input type="checkbox"/> Oct.</td> </tr> <tr> <td><input type="checkbox"/> 2018</td> <td><input type="checkbox"/> Feb.</td> <td><input type="checkbox"/> May</td> <td><input type="checkbox"/> Aug.</td> <td><input type="checkbox"/> Nov.</td> </tr> <tr> <td><input type="checkbox"/> 2019</td> <td><input type="checkbox"/> Mar.</td> <td><input type="checkbox"/> Jun.</td> <td><input type="checkbox"/> Sep.</td> <td><input type="checkbox"/> Dec.</td> </tr> </table>	<input type="checkbox"/> 2017	<input type="checkbox"/> Jan.	<input type="checkbox"/> Apr.	<input type="checkbox"/> Jul.	<input type="checkbox"/> Oct.	<input type="checkbox"/> 2018	<input type="checkbox"/> Feb.	<input type="checkbox"/> May	<input type="checkbox"/> Aug.	<input type="checkbox"/> Nov.	<input type="checkbox"/> 2019	<input type="checkbox"/> Mar.	<input type="checkbox"/> Jun.	<input type="checkbox"/> Sep.	<input type="checkbox"/> Dec.
L.P.	N.G.	L.P.	N.G.																														
Input Rate on "HI" (BTU/Hr) 25,000	13,000	Minimum Inlet Pressure (inches W.C.) 11"	5.5"																														
Input Rate on "LO" (BTU/Hr) 1,450mm	#42	Maximum Inlet Pressure (inches W.C.) 13"	7"																														
Orifice Size - (DMS)		Manifold Pressure on "HI" (inches W.C.) 11"	3.8"																														
<input type="checkbox"/> 2017	<input type="checkbox"/> Jan.	<input type="checkbox"/> Apr.	<input type="checkbox"/> Jul.	<input type="checkbox"/> Oct.																													
<input type="checkbox"/> 2018	<input type="checkbox"/> Feb.	<input type="checkbox"/> May	<input type="checkbox"/> Aug.	<input type="checkbox"/> Nov.																													
<input type="checkbox"/> 2019	<input type="checkbox"/> Mar.	<input type="checkbox"/> Jun.	<input type="checkbox"/> Sep.	<input type="checkbox"/> Dec.																													



ProBuilder 42
 Linear MV
 ProBuilder 42
 Linear GSB2

Vented Gas Fireplace Heater
 Not for use with solid fuel

Tested to: ANSI Z21.88-2016/CSA 2.33-2016 "Vented Gas Fireplace Heater", CGA 2.17-M91 (R2014) "Gas-fired appliances for use at high altitudes", and CSA P-1-15 Testing method for measuring annual fireplace efficiency.

This appliance must be installed in accordance with local codes, if any; if none, follow the National Fuel Gas Code, ANSI Z223.1/NFPA 54, or Natural Gas and Propane Installation Codes, CSA B149.1. This appliance must be installed in accordance with the current Standard CAN/CSA Z240 MH, Mobile Housing, in Canada or with the Manufactured Home Construction and Safety Standard, Title 24 CFR, Part 3280, in the United States, or when such a standard is not applicable, ANSINC/S-BCS A225.1/NFPA 501A, Manufactured Home Installation Standard.

This vented gas fireplace heater is equipped at the factory for use with natural gas. If conversion to propane (LP) is desired, the optional factory conversion kit must be used. Part No. 250-04278 (GSB2) or 250-04264 (MV) kit may be used.

This appliance is only for use with the type(s) of gas indicated on the rating plate and may be installed in an aftermarket, permanently located, manufactured home (USA only) or mobile home, where not prohibited by local codes. See owner's manual for details. This appliance is not convertible for use with other gases, unless a certified kit is used.

This vented gas fireplace heater is not for use with air filters.
 Keep burner and control compartment clean. See installation and operating instructions accompanying appliance.

This appliance must be properly connected to a venting system in accordance with the manufacturer's installation instructions. Use only an approved direct vent system to vent this appliance to the exterior. See owner's manual for approved brands of venting.
 If the vent-air intake system is disconnected for servicing or any other reason, it must be resealed and / or reinstalled.

WARNING: Improper installation, adjustment, alteration, service or maintenance can cause injury or property damage. Refer to the owner's information manual provided with this appliance. For assistance or additional information consult a qualified installer, service agency or the gas supplier.

CAUTION: Do not operate this appliance with glass removed, cracked or broken. Replacement of the panel(s) should be done by a licensed or qualified service person. Hot while in operation. Do not Touch. Severe burns may result. Keep children, clothing, furniture, gasoline and other flammable liquids having flammable vapors away.

XXXX

54 ProBuilder Safety Label

The safety (listing) label is attached to the operating tag (chained to the heater near the gas control valve). A copy is shown below

<p>Fireplace to Adjacent Wall 0" (0mm)</p> <p>Wood Floor Beneath Fireplace 0" (0mm)</p> <p>Back To Enclosure 0.5" (13mm)</p>		<p>Minimum Clearances to Combustibles</p> <p>Base Of Fireplace To Enclosure Top 54.5" (1385mm)</p> <p>Sides To Enclosure 0.5" (13mm)</p> <p>Base Of Fireplace To A Mantel See Owner's Manual</p>	
<p>FAN TYPE VENTED CIRCULATOR (OPTIONAL)</p>			
<p>Blower Electrical Rating: 120 VAC, 4.5 Amps, 60 Hz, 540 Watts (Part No. 250-04395) fan or blower assembly may be used. For use only with factory barrier (see "Glass Frame Removal" in the installation manual for part numbers). Follow installation instructions.</p>			
Input Rate on "HI" (BTU/Hr)	L.P.	N.G.	L.P. N.G.
Input Rate on "LO" (BTU/Hr)	33,000	33,000	Minimum Inlet Pressure (inches W.C.) 11" 5.5"
Orifice Size - (DMS)	1.65mm	#36	Maximum Inlet Pressure (inches W.C.) 13" 7"
			Manifold Pressure on "HI" (inches W.C.) 11" 3.8"

This appliance is equipped for use only at altitudes 0-2,000 feet (0-610m) in the USA. In Canada, 0-4,500 feet (0-1370m). For altitudes above 2,000 feet, the vent configuration, orifice, or combination of both may be need to be changed. See owner's manual for information on making these changes.

ProBuilder 54

Linear MV

ProBuilder 54

Linear GSB2

Vented Gas Fireplace Heater
Not for use with solid fuel

Tested to: ANSI Z21.88-2016/CSA 2.23-2016 "Vented Gas Fireplace Heater", CGA 2.17-IM91 (R2014) "Gas-fired appliances for use at high altitudes", and CSA P.4.1-15 Testing method for measuring annual fireplace efficiency.

This appliance must be installed in accordance with local codes, if any; if none, follow the National Fuel Gas Code, ANSI Z223.1/NFPA 54, or Natural Gas and Propane Installation Codes, CSA B149.1.

This appliance must be installed in accordance with the current Standard CAN/CSA Z240 MH, Mobile Housing, in Canada or with the Manufactured Home Construction and Safety Standard, Title 24 CFR, Part 3280, in the United States, or when such a standard is not applicable, ANSI/NCS-BCS A225.1/NFPA 501A, Manufactured Home Installation Standard.

This vented gas fireplace heater is equipped at the factory for use with natural gas. If conversion to propane (LP) is desired, the optional factory conversion kit must be used. Part No. 250-04559 (GSB2) or 250-04558 (MV) kit may be used.

This appliance is only for use with the type(s) of gas indicated on the rating plate and may be installed in an aftermarket, permanently located, manufactured home (USA only) or mobile home, where not prohibited by local codes. See owner's manual for details. This appliance is not convertible for use with other gases, unless a certified kit is used.

This vented gas fireplace heater is not for use with air filters.

Keep burner and control compartment clean. See installation and operating instructions accompanying appliance.

This appliance must be properly connected to a venting system in accordance with the manufacturer's installation instructions. Use only an approved direct vent system to vent this appliance to the exterior. See owner's manual for approved brands of venting.

If the vent-air intake system is disconnected for servicing or any other reason, it must be resealed and / or reinstalled.

WARNING: Improper installation, adjustment, alteration, service or maintenance can cause injury or property damage. Refer to the owner's information manual provided with this appliance. For assistance or additional information consult a qualified installer, service agency or the gas supplier.

Manufactured by:



TRAVIS INDUSTRIES
HOUSE OF FIRE
12521 Harbour Reach Drive
Midwite, WA 98275
www.travisproducts.com

MANUFACTURE DATE:

<input type="checkbox"/> 2017	<input type="checkbox"/> Jan.	<input type="checkbox"/> Apr.	<input type="checkbox"/> Jul.	<input type="checkbox"/> Oct.
<input type="checkbox"/> 2018	<input type="checkbox"/> Feb.	<input type="checkbox"/> May	<input type="checkbox"/> Aug.	<input type="checkbox"/> Nov.
<input type="checkbox"/> 2019	<input type="checkbox"/> Mar.	<input type="checkbox"/> Jun.	<input type="checkbox"/> Sep.	<input type="checkbox"/> Dec.

CAUTION: Do not operate this appliance with glass removed, cracked or broken. Replacement of the panel(s) should be done by a licensed or qualified service person. Hot while in operation. Do not Touch. Severe burns may result. Keep children, clothing, furniture, gasoline and other flammable liquids having flammable vapors away.

XXXX

72 ProBuilder Safety Label

The safety (listing) label is attached to the operating tag (chained to the heater near the gas control valve). A copy is shown below

ProBuilder 72
Linear MV
ProBuilder 72
Linear GSB2

Vented Gas Fireplace Heater
Not for use with solid fuel

Tested to: ANSI Z21.88-2016/CSA 2.33-2016 "Vented Gas Fireplace Heater", CGA 2.17-M91 (R2014) "Gas-fired appliances for use at high altitudes", and CSA P.4.1-15 Testing method for measuring annual fireplace efficiency.

This appliance must be installed in accordance with local codes, if any, if none, follow the National Fuel Gas Code, ANSI Z223.1/NFPA 54, or Natural Gas and Propane Installation Codes, CSA B149.1.

This appliance must be installed in accordance with the current Standard CAN/CSA Z240 MH, Mobile Housing, in Canada or with the Manufactured Home Construction and Safety Standard, Title 24 CFR, Part 3280, in the United States, or when such a standard is not applicable, ANSINCS-BCS A225.1/NFPA 501A, Manufactured Home Installation Standard.

This vented gas fireplace heater is equipped at the factory for use with natural gas. If conversion to propane (LP) is desired, the optional factory conversion kit must be used. Part No. 250-04489 (GSB2) or 250-04488 (MV) kit may be used.

This appliance is only for use with the type(s) of gas indicated on the rating plate and may be installed in an aftermarket, permanently located, manufactured home (USA only) or mobile home, where not prohibited by local codes. See owner's manual for details. This appliance is not convertible for use with other gases, unless a certified kit is used.

This vented gas fireplace heater is not for use with air filters. Keep burner and control compartment clean. See installation and operating instructions accompanying appliance.

This appliance must be properly connected to a venting system in accordance with the manufacturer's installation instructions. Use only an approved direct vent system to vent this appliance to the exterior. See owner's manual for approved brands of venting.

If the vent-air intake system is disconnected for servicing or any other reason, it must be resealed and / or reinstalled.

WARNING: Improper installation, adjustment, alteration, service or maintenance can cause injury or property damage. Refer to the owner's information manual provided with this appliance. For assistance or additional information consult a qualified installer, service agency or the gas supplier.

Minimum Clearances to Combustibles

Fireplace to Adjacent Wall	0" (0mm)	Base Of Fireplace To Enclosure Top	68" (1728mm)
Wood Floor Beneath Fireplace	0" (0mm)	Sides To Enclosure	0.5" (13mm)
Back To Enclosure	0.5" (13mm)	Base Of Fireplace To A Mantel	See Owner's Manual

FAN TYPE VENTED CIRCULATOR (OPTIONAL)

Blower Electrical Rating: 120 VAC, 4.5 Amps, 60 Hz, 540 Watts (Part No. 250-04395) fan or blower assembly may be used. For use only with factory barrier (see "Glass Frame Removal" in the installation manual for part numbers). Follow installation instructions.

Input Rate on "HI" (BTU/Hr)	45,000	Minimum Inlet Pressure (inches W.C.)	11"	L.P.	5.5"
Input Rate on "LO" (BTU/Hr)	23,000	Maximum Inlet Pressure (inches W.C.)	13"	M.G.	7"
Orifice Size - (DMS)	#54 (2)	Manifold Pressure on "HI" (inches W.C.)	11"		3.8"

This appliance is equipped for use only at altitudes 0-2,000 feet (0-610m) in the USA. In Canada, 0-4,500 feet (0-1370m). For altitudes above 2,000 feet, the vent configuration, orifice, or combination of both may be need to be changed. See owner's manual for information on making these changes.

MANUFACTURE DATE:

<input type="checkbox"/> 2017	<input type="checkbox"/> Jan.	<input type="checkbox"/> Apr.	<input type="checkbox"/> Jul.	<input type="checkbox"/> Oct.
<input type="checkbox"/> 2018	<input type="checkbox"/> Feb.	<input type="checkbox"/> May	<input type="checkbox"/> Aug.	<input type="checkbox"/> Nov.
<input type="checkbox"/> 2019	<input type="checkbox"/> Mar.	<input type="checkbox"/> Jun.	<input type="checkbox"/> Sep.	<input type="checkbox"/> Dec.

Manufactured by:

TRAVIS INDUSTRIES
HOUSE OF FIRE
12521 Harbour Reach Drive
Mukilteo, WA 98275
www.travisproducts.com

CAUTION: Do not operate this appliance with glass removed, cracked or broken. Replacement of the panel(s) should be done by a licensed or qualified service person. Hot while in operation. Do not Touch. Severe burns may result. Keep children, clothing, furniture, gasoline and other flammable liquids having flammable vapors away.

XXXX

Register your TRAVIS INDUSTRIES, INC. Limited 7 Year Warranty online at traviswarranty.com. TRAVIS INDUSTRIES, INC. warrants this gas appliance (appliance is defined as the equipment manufactured by Travis Industries, Inc.) to be defect-free in material and workmanship to the original purchaser from the date of purchase as follows:

Check with your dealer in advance for any costs to you when arranging a warranty call.
Mileage or service charges are not covered by this warranty. This charge can vary from store to store.

Component	Years 1 & 2 Parts & Labor	Years 3 Through 5 Parts & Labor	Years 6 & 7 Parts Only
Burner Assembly Burner Pan Assembly, Air Shutter Assembly, Main Burner Orifice	✓		
Electrical Assembly (within heater structure): Wiring harness, snap discs, rheostat speed control	✓		
Gas Control Assembly Adjustable control valve, fireplace controller, pilot assembly and pilot wiring	✓		
Glass Glass (breakage from thermal shock)	✓		
Gold, Nickel & Copper Plating Face & Door (see "Conditions and Exclusions" # 9)	✓		
Accessories Firebacks, Power Heat Ducts, Andirons, etc...	✓		
One-Way Freight Allowance One-way freight allowance on pre-authorized repair done at factory is covered.	✓	✓	
Convection Heat Exchanger Convection heat exchanger assembly	✓	✓	
Firebox Assembly Adjustable Air Restrictor, Pressure Relief Mechanisms, Glass Attachment Mechanism	✓	✓	✓

EXCLUDED COMPONENTS:

Paint, Gasketing, and Accent Light Bulbs

CONDITIONS & EXCLUSIONS

- This new gas appliance must be installed by a qualified gas appliance technician. It must be installed, operated, and maintained at all times in accordance with the instructions in the Owner's Manual. Any alteration, willful abuse, accident, neglect, or misuse of the product shall nullify this warranty.
- This warranty is nontransferable, and is made to the ORIGINAL purchaser, provided that the purchase was made through an authorized TRAVIS dealer.
- Discoloration and some minor expansion, contraction, or movement of certain parts and resulting noise, is normal and not a defect and, therefore, not covered under warranty. The installer must ensure the appliance is burning as per the rating tag at the time of installation. Over-firing (operation above the listed BTU rate) of this appliance can cause serious damage and will nullify this warranty.
- The warranty, as outlined within this document, does not apply to the chimney components or other Non-Travis accessories used in conjunction with the installation of this product. If in doubt as to the extent of this warranty, contact your authorized TRAVIS retailer before installation.
- Travis Industries will not be responsible for inadequate performance caused by environmental conditions such as nearby trees, buildings, roof tops, wind, hills or mountains or negative pressure or other influences from mechanical systems such as furnaces, fans, clothes dryers, etc.
- This Warranty is void if:
 - The unit has been operated in atmospheres contaminated by chlorine, fluorine or other damaging chemicals.
 - The unit is subject to submersion in water or prolonged periods of dampness or condensation.
 - Any damage to the unit, combustion chamber, heat exchanger or other components due to water, or weather damage which is the result of, but not limited to, improper chimney/venting installation.
- Exclusions to this 7 Year Warranty include: injury, loss of use, damage, failure to function due to accident, negligence, misuse, improper installation, alteration or adjustment of the manufacturer's settings of components, lack of proper and regular maintenance, damage incurred while the appliance is in transit, alteration, or act of God.
- This 7 Year warranty excludes damage caused by normal wear and tear, such as paint discoloration or chipping, worn or torn gasketing, corroded or cracked logs, embers, etc. Also excluded is damage to the unit caused by abuse, improper installation, modification of the unit, drilling of the orifices, or the use of fuel other than that for which the unit is configured. Units are shipped for natural gas and must be converted to propane using the included conversion kit. Confirm fuel configuration with your installer.
- Damage to gold or nickel surfaces caused by fingerprints, scratches, melted items, or other external sources left on the gold or nickel from the use of cleaners other than denatured alcohol is not covered in this warranty.
- TRAVIS INDUSTRIES, INC. is free of liability for any damages caused by the appliance, as well as inconvenience expenses and materials. Incidental or consequential damages are not covered by this warranty. In some states, the exclusion of incidental or consequential damage may not apply.
- This warranty does not cover any loss or damage incurred by the use or removal of any component or apparatus to or from the gas appliance without the express written permission of TRAVIS INDUSTRIES, INC. and bearing a TRAVIS INDUSTRIES, INC. label of approval.
- Any statement or representation of TRAVIS products and their performance contained in TRAVIS advertising, packaging literature, or printed material is not part of this 7 year warranty.
- This warranty is automatically voided if the appliance's serial number has been removed or altered in any way. If the appliance is used for commercial purposes, it is excluded from this warranty.
- No dealer, distributor, or similar person has the authority to represent or warrant TRAVIS products beyond the terms contained within this warranty. TRAVIS INDUSTRIES, INC. assumes no liability for such warranties or representations.
- Travis Industries will not cover the cost of the removal or re-installation of hearths, facing, mantels, venting or other components.
- If for any reason any section of this warranty is declared invalid, the balance of the warranty remains in effect and all other clauses shall remain in effect.
- THIS 7 YEAR WARRANTY IS THE ONLY WARRANTY SUPPLIED BY TRAVIS INDUSTRIES, INC., THE MANUFACTURER OF THE APPLIANCE. ALL OTHER WARRANTIES, WHETHER EXPRESS OR IMPLIED, ARE HEREBY EXPRESSLY DISCLAIMED AND PURCHASER'S RECOURSE IS EXPRESSLY LIMITED TO THE WARRANTIES SET FORTH HEREIN.**

IF WARRANTY SERVICE IS NEEDED:

- If you discover a problem that you believe is covered by this warranty, you MUST REPORT it to your TRAVIS dealer WITHIN 30 DAYS, giving them proof of purchase, the purchase date, and the model name and serial number.
- Travis Industries has the option of either repairing or replacing the defective component.
- If your dealer is unable to repair your appliance's defect, he may process a warranty claim through TRAVIS INDUSTRIES, INC., including the name of the dealership where you purchased the appliance, a copy of your receipt showing the date of the appliance's purchase, and the serial number on your appliance. At that time, you may be asked to ship your appliance, freight charges prepaid, to TRAVIS INDUSTRIES, INC. TRAVIS INDUSTRIES, INC., at its option, will repair or replace, free of charge, your TRAVIS appliance if it is found to be defective in material or workmanship within the time frame stated within this 7 year warranty. TRAVIS INDUSTRIES, INC. will return your appliance, freight charges (years 1 to 5) prepaid by TRAVIS INDUSTRIES, INC., to your regional distributor, or dealership.
- Check with your dealer in advance for any costs to you when arranging a warranty call. Mileage or service charges are not covered by this warranty. This charge can vary from store to store.

Index

Adjusting the Blower Speed (Optional).....	8	Maintaining Your Heater's Appearance	16
Adjusting the Flame Height.....	7	Normal Operating Odors.....	10
Before You Begin	6	Pilot Fuel Conservation Timer	9
Continuous Pilot / GreenSmart™ Pilot Switch ...	8	Power Outages	10
Crushed Glass Installation	14	Replacement Parts List.....	19
Features	3	Starting the Fireplace for the First Time	7
Glass Frame Removal and Installation	11	Starting the Heater for the First Time	10
Heating Specifications.....	3	Turning the Fireplace On and Off	7
Important Information	2	Wiring Diagram	20
Installation Warnings.....	2	Yearly Service Procedure	17
Location of Controls	6		