

SCAN FOR BILT: 3D INSTRUCTIONS



Powered by BILT Intelligent Instructions®

Installation
Instructions

ELECTRONIC IGNITION FIRE PIT INSERT

SCAN FOR BILT: 3D INSTRUCTIONS



Powered by BILT Intelligent Instructions®

Troubleshooting
Instructions



PENTA24EI

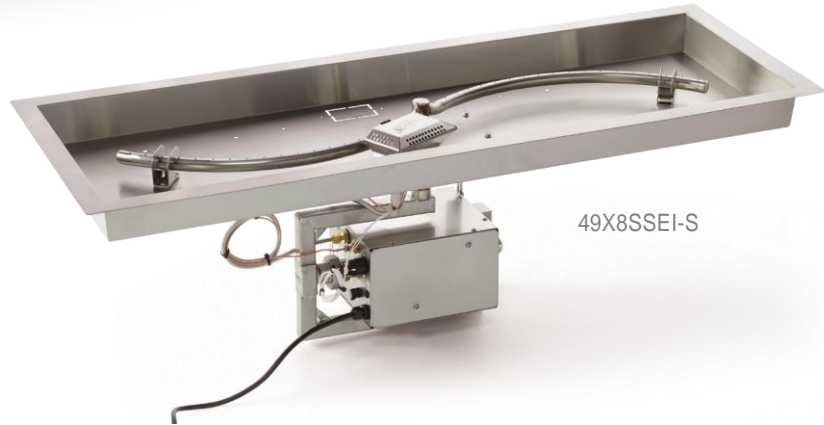

49X8SSEI-S

EI Series

Bluetooth High/Low Flame Control Models

Installation & Operation Instructions

Before you begin >>>

3D INTERACTIVE INSTRUCTIONS FOR THIS PRODUCT ARE IN

BILT.
Intelligent Instructions

DOWNLOAD THE FREE APP

Download on the App Store | GET IT ON Google Play



FIRE INSPIRED™
Hearth Products Controls
Fire-inspired since 1975.
860-EI HI/LO



C US

NATIONAL
FIREPLACE
INSTITUTE





This is a Safety Alert Symbol

When you see this symbol on the fire pit insert, or in this manual, look for one of the following signal word panels alerting you to the potential for personal injury, death or major property damage.



WARNING: For Outdoor Use Only.

Installation and service must be performed by a qualified installer, service agency, or the gas supplier.



WARNING

Do not store or use gasoline or other flammable vapors and liquids in vicinity of this or any other appliance.

An LP-cylinder not connected for use shall not be stored in the vicinity of this or any other appliance.



DANGER

FIRE OR EXPLOSION HAZARD

If you smell gas:

- **Shut off gas to the appliance.**
- **Extinguish an open flame.**
- **If odor continues, leave the area immediately.**
- **After leaving the area, call your gas supplier or fire department.**

Failure to follow these instructions could result in fire or explosion, which could cause property damage, personal injury, or death.



DANGER

CARBON MONOXIDE HAZARD

This appliance can produce carbon monoxide which has no odor.

Using it in an enclosed space can kill you.

Never use this appliance in an enclosed space such as a camper, tent, car or home.



INSTALLER: Leave this manual with the appliance.

CONSUMER: Retain this manual for future reference.



WARNING: If the information in this manual is not followed exactly, a fire or explosion may result causing property damage, personal injury, or loss of life.

Table of Contents

1 Important Safety Information	3
Technical Support	3
Symbol Legend	4
Important Safety Information for Installers	5
Important Safety Information for End-Users.....	6
2 Product Features and Parts List	7
3 Selecting the Fire Pit Location	8
4 Overhead Structures and Sidewall Clearance Requirements	9
5 Fire Pit Enclosures Requirements	11
6 Installing the Fire Pit	13
7 Adding Approved Media	17
8 Operating the Fire Pit	19
9 Maintaining the Fire Pit	25
10 Troubleshooting	26
11 Wiring Diagram	28
12 Compatible Accessories	29
13 Replacement Parts	29
14 Warranty	31

1 Important Safety Information

- Hearth Products Controls Company recommends that our products are installed by professionals locally licensed by the authority having jurisdiction in gas piping. All installation instructions must be followed to ensure proper performance and safety. Hearth Products Controls Company assumes no responsibility for problems relating to the installation.
- To qualify for warranty, all instructions must be strictly followed. Otherwise, warranty may be void. Never alter product or configuration in any way.
- Annual servicing should be handled by professionals certified in the US by the National Fireplace Institute (NFI) as NFI Gas Specialists or in Canada by WETT (Wood Energy Technical Training).
- It is the installer's responsibility to ensure a safe installation and to educate the end-user regarding the features, safety recommendations and proper operation of this product.
- Please reference page 1 for all warnings.

INSTALLER:

Leave this manual with the appliance.

END USER:

Retain this manual for future reference.

SELECT MODELS

**Certified to
ANSI Z21.97-2014
CSA 2.41-2014**



ATTENTION:

For the HPC Fire app, the default security code is:

2 3 4 5



Technical Support

For information and support contact your Hearth Products Controls dealer.

1 Important Safety Information

Symbol Legend



This is a Safety Alert Symbol

When you see this symbol on the fire pit insert, or in this manual, look for one of the following signal word panels alerting you to the potential for personal injury, death or major property damage.



Necessary instructions



1 Important Safety Information

Please reference page 1 for all warnings.

Important Safety Information for Installers

Leave this manual with the end-user and instruct them to retain it for future reference. Instructions and product updates are also available at www.hpcfire.com under the Support tab.

Installers must carefully follow the instructions in this manual to prevent personal injury or property loss. These instructions contain information critical to the safe installation and operation of the fire pit.

- Instructions are updated as needed. It is the responsibility of the installers to check for product updates and installation manual updates at www.hpcfire.com/support.html prior to installation.
- It is the responsibility of the installer to follow:
 - The National Fuel Gas Code, ANSI Z223.1/NFPA 54 or International Fuel Gas Code.
 - Natural Gas and Propane Installation Code CSA B149.1 or CSA B149.2.
 - The National Electrical Code, ANSI/NFPA 70. In Canada, Canadian Electrical Code CSA 22.1.
 - Local codes
- **Control options:** Bluetooth® technology only allows use with the supplied remote control or a smartphone or tablet.

Gas

- Only use the gas/fuel type specified for this fire pit, refer to the label on the fire pit control box. Never use an alternative fuel to include biofuel, ethanol, lighter fluid or any other fuel.
- Gas pressure and type should be checked prior to use and installation.
 - **Natural Gas Fire Pit:** Supply Pressure: Minimum: 6.0 inches W.C.; Maximum: 7.0 inches W.C.
 - **LP Gas:** Supply Pressure: Minimum: 8.0 inches W.C.; Maximum: 11.0 inches W.C.

IMPORTANT

If pressure is low, this will reduce flame height on HIGH setting, possibly resulting in little to no flame variation.

1 Important Safety Information

- If not using supplied flex line, ensure any flex line that may be used from the permanent main fuel supply to the product is rated to the stated max BTU of the product and certified to ANSI Z21.75*CSA 6.27.
- The EI Series is not for use with small LP Tanks and must utilize permanent fixed piping for fuel supply.

Electrical

- Verify correct 120 VAC – 1 amp or 24 VAC – 4 amp power supply. Only use the type specified for this fire pit. Refer to the label on the fire pit control box. All electronic applications should utilize a GFCI-protected circuit.
 - If removing power cord plug and hard wiring within junction box, use only a certified Electrician and must follow the National Electrical Code (NEC), NFPA 70 and all local codes.

IMPORTANT

24 VAC powered fire pit inserts:

- Fire Pit will not perform properly if power supply rating is below 100W or wire size is too small.
- HPC highly recommends using our HPC/Sebco 24 VAC 100W power supply series (311-PS1, 311-PS3, 311-PS5 Models)

A Class II 24 VAC, 4 amp, 100 W transformer must be used to power the fire pit and be able to be switched on and off from a remote location to allow for easy access or emergency.

- 24 VAC wire sizing: Wire lengths 75 ft or less: 14 gauge
- Wire lengths 76 ft or more: 12 gauge

Important Safety Information for End-Users

- Never leave an operating fire pit unattended or with someone not familiar with its operation or emergency shut-off locations.
- Both children and adults should be alerted to the hazards of high surface temperatures and should stay away to avoid burns and clothing ignition.
- Young children should be carefully supervised when they are in the area of fire pit.
- Keep the appliance area clear and free from combustible materials, gasoline, and other flammable vapors and liquids.

2 Product Features and Parts List

Product Features

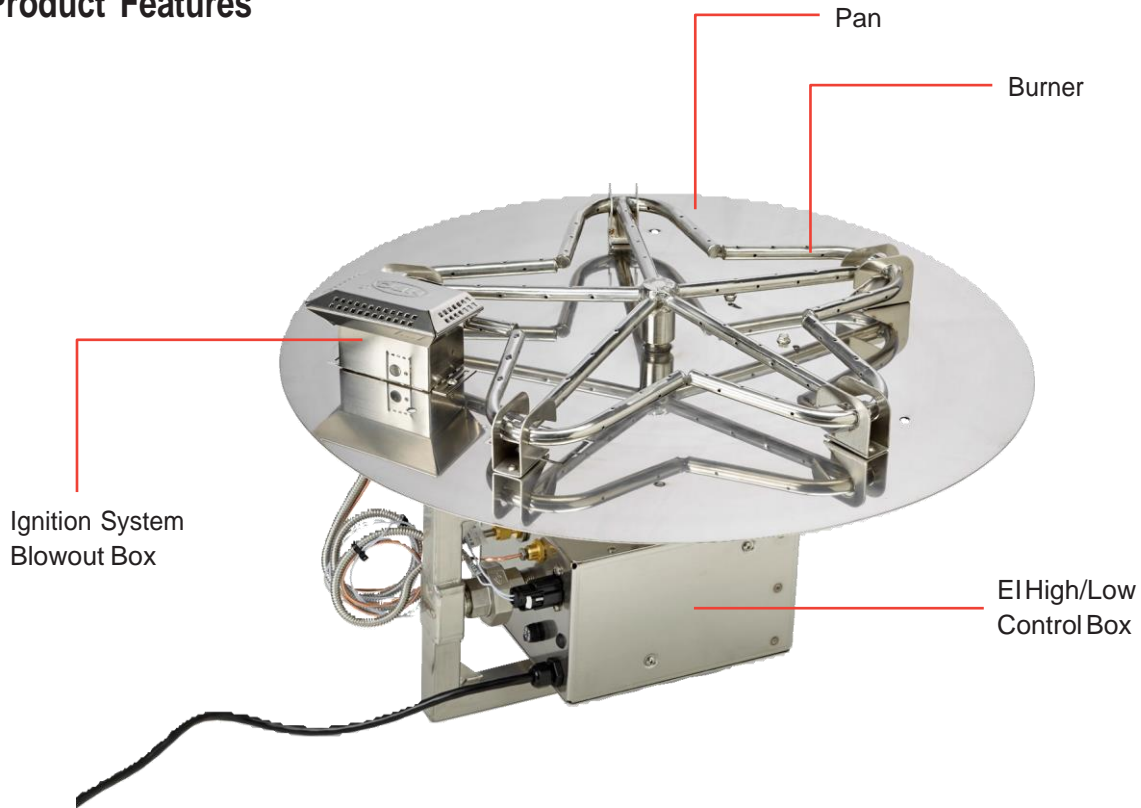

Parts List

- Fire Pit Insert
- Gas Input Flex Line – 24"
- Installation and Operation Instructions
- Remote Control (Bluetooth) & Antenna Extension Cable

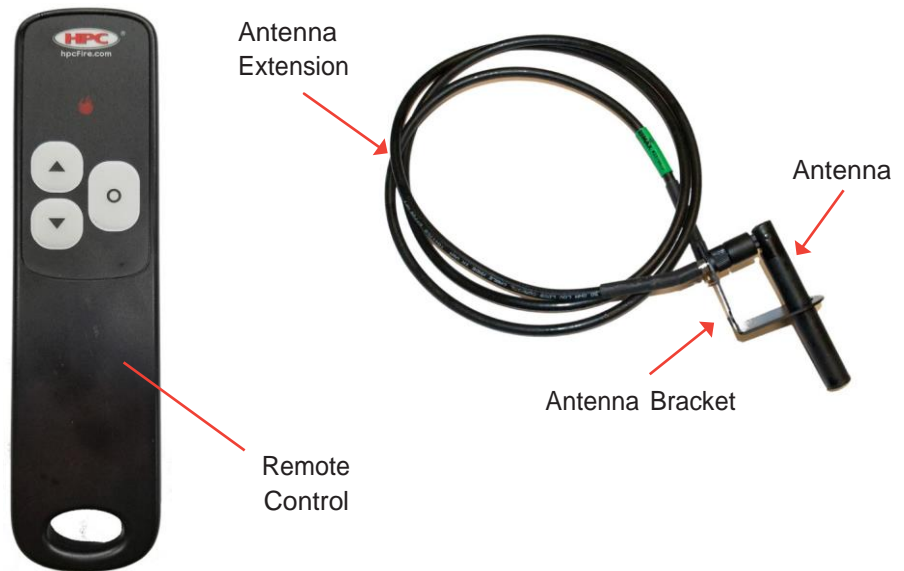

3 Selecting the Fire Pit Location

NOTE: All fire pits and systems are designed and intended for outdoor use only.

IMPORTANT

It is recommended that material such as granite, marble or other dense stone be kept away from heat and especially flame due to risk of cracking. HPC is not responsible for damage resulting from failure to follow these recommendations.

- Select a location that
 - ensures above-grade installation of the fire pit.
 - offers good drainage.
 - allows easy access for installation and maintenance of the fire pit.
 - provides sufficient horizontal room to enjoy the fire pit while allowing a safe distance from the heat and flame.

IMPORTANT

Deck installation — If installing fire pit on a wood or composite deck, it is required to use the Deck Insulation Kit(s) and locally bought paver stones. Kit includes basalt material and instructions.

#FPI-DECK39SQ; #FPI-DECK20SQ. Also refer to drawing- Deck Insulation Kit- Install.

- Fire pits create very high temperatures. For clearances refer to table 3.1. Clothing or other flammable materials should not be placed on or near fire pit.

Clearances around Fire Pit

Fire Pit Clearances	Up to 200k BTU	201k ~ 400k BTU
Under Valve Box when applicable for drainage	2"	2"
Sides surrounding fire pit from structure or combustibles	36" (12" for noncombustibles)	48" (24" for noncombustible)
Overhead clearance above product	84"	Non-combustible screen only

Table 3.1 – Fire Pit Clearances

4 Overhead Structures and Sidewall Clearance Requirements

It's important to review the clearance requirements below for any type of overhead structure such as pergola, roof, overhang, screens, arbor, etc. or a sidewall to ensure that the distances are met. Figures 4.1 and 4.2.

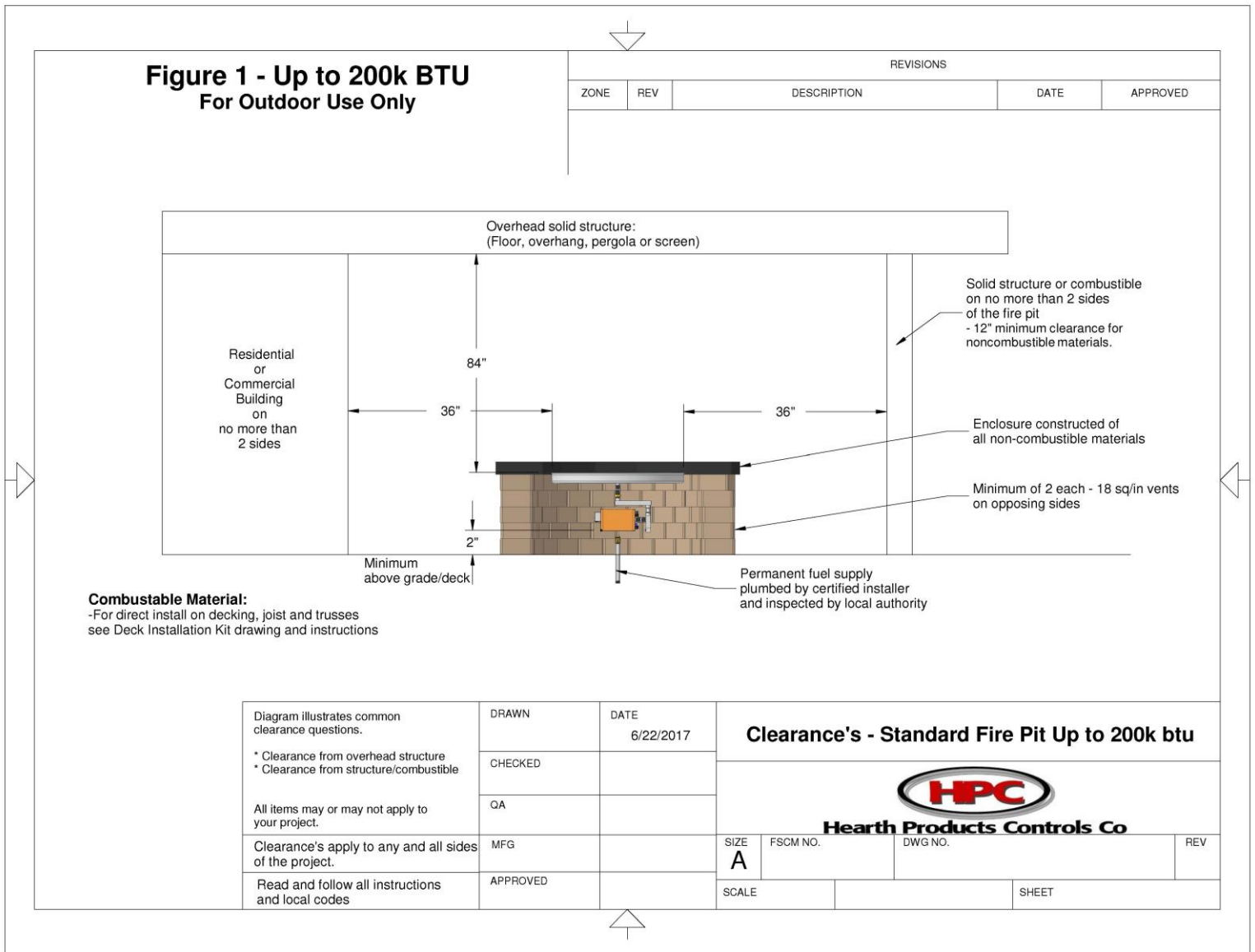
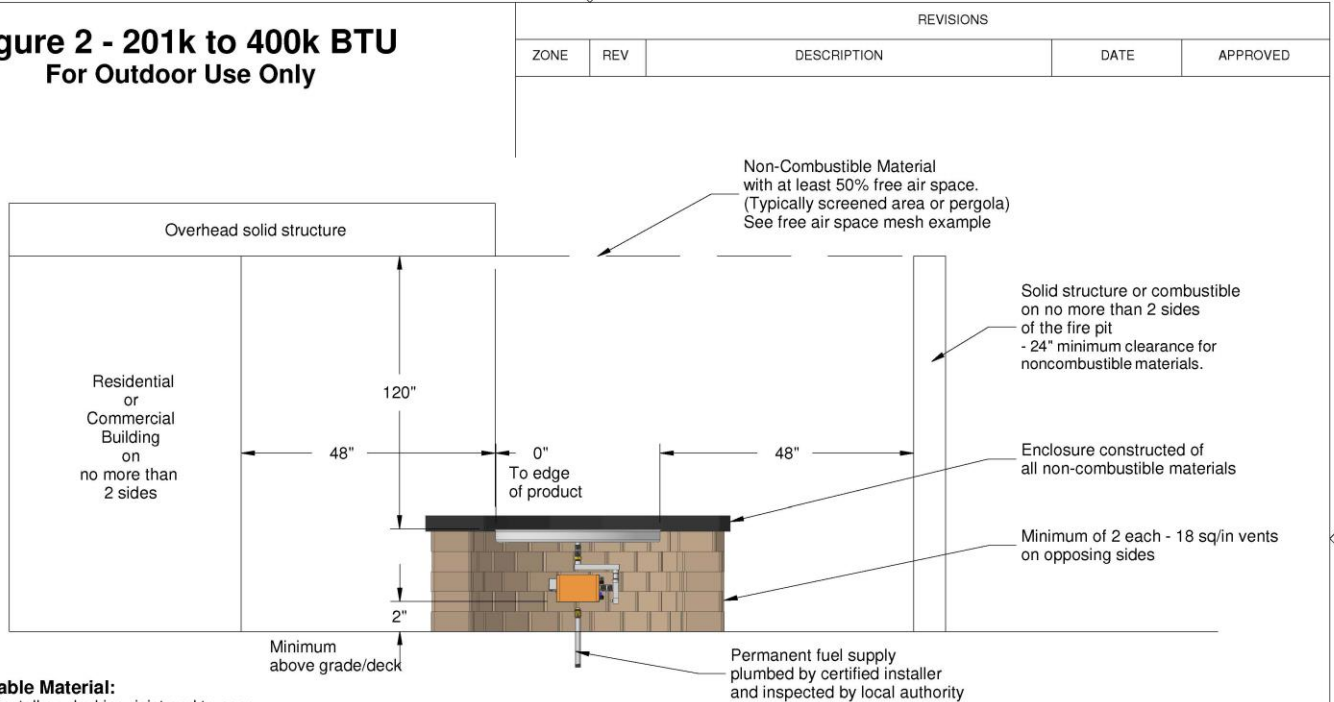

Table 4.1 – Clearances for standard fire pit up to 200k BTU

4 Overhead Structures and Sidewall Clearance Requirements

**Figure 2 - 201k to 400k BTU
For Outdoor Use Only**



Combustible Material:
-For direct install on decking, joist and trusses
see Deck Installation Kit drawing and instructions

Note:
-50% free air space minimum. HPC is not responsible for screen that melts.
-For non-combustible screening a 20 x 20 x .013 wire mesh thickness or courser. (More open space)
-For all other non-combustible coverings an on-site estimate of free air space will be necessary.

Free Air Space Mesh Example
3:1 Scale of 20x20x.013

Diagram illustrates common clearance questions. * Clearance from overhead structure * Clearance from structure/combustible All items may or may not apply to your project. Clearance's apply to any and all sides of the project. Read and follow all instructions and local codes	DRAWN	DATE
	CHECKED	6/22/2017
	QA	
	MFG	
	APPROVED	

Clearance's - Standard Fire Pit 201k to 400k btu			
 Hearth Products Controls Co			
SIZE	FSCM NO.	DWG NO.	REV
A			
SCALE		SHEET	

Table 4.2 – Clearances for standard fire pit up to 201k to 400k BTU

5 Fire Pit Enclosures Requirements

Location and design

- The enclosure must be installed above-grade and allow for drainage to prevent water damage to fire pit.
- Refer to cut sheets on our website for important dimensional information for your fire pit. Visit www.hpcfire.com
- The fire pit assembly should be recessed a minimum of two inches from the top of the enclosure to protect flame from being blown out.
- It is recommended that material such as granite, marble or other dense stone be kept away from heat and especially flame due to risk of cracking. Manufacturer is not responsible for damage.
- The enclosure must be constructed on a stable surface and be level. HPC recommends the use of the installation collar (optional) that may be mortared into or sandwiched between layers of the enclosure.
- The weight of the fire pit must be supported by the pan and not by any control/valve box.
- HPC recommends that the pan lip is recessed on a trough (linear), and large round enclosures, Figure 5.1.

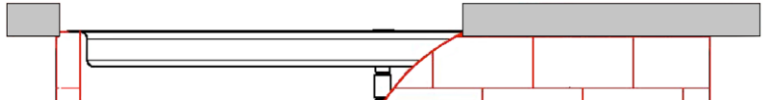

Figure 5.1 – Pan lip recessed on a trough.

NOTE: HPC cannot guarantee the lip on all of our products will be perfectly flat and will not warp due to heat.

- There must be a minimum of 2 inches under the valve box for proper ventilation and drainage, see clearance drawings on page 9 an 10.
- The product must be accessible for service.

Gas

- Fire pit must have a gas shutoff on the exterior of the fire pit to allow for emergency shut off and maintenance. The gas shutoff should NOT be used to adjust flame height.
- Fuel line sizing is the responsibility of the installer and must be able to supply the stated maximum BTU for the product – refer to product label on fire pit.

5 Fire Pit Enclosures Requirements

Construction materials

- Use non-combustible materials and construction for gas supply, power and enclosure.
- The interior void space of the enclosure surrounding the valve box cannot be filled with any material (gravel, crushed rock, concrete, etc.).

Venting

- The enclosure must incorporate at least two vents to allow heat and or residual fuel to escape. Failure to properly vent the enclosure may result in the fire pit overheating or explosion.
- Some enclosures may require more ventilation based on material, size, and extended use.
- The vent may also work as a drain when installed at bottom sidewall to prevent water build up.
- Vent specifications:
 - A minimum of two vents (18 square inches for each vent) on opposing sides of the enclosure totaling 36 inches of free area are required (example: 3-inch x 6-inch or larger). Or, multiple vents uniformly made throughout the enclosure totaling 36 square inches or more of free area are acceptable.
 - We recommend 4 vents total to reduce the risk of thermal shutdown.
 - Installation of the vents in the mid-to-lower area of the enclosure is recommended.
- Failure to properly vent the enclosure may result in the fire pit overheating or explosion. Continuous overheating could lead to heat damage to internal components.
- When installing insert inside a non-HPC copper or concrete bowl, ventilation should be below the bowl. If bowl is mounted on top of a column, a 6" hole is recommended to allow gas supply, electrical and water plumbing to clear.
- **OVERHEATING:** the fire pit will automatically close the gas valve if the temperature exceeds 190°F inside the valve box to prevent component damage. Turn main power to the fire pit off and on to reset. To correct overheating, ensure enclosure has adequate ventilation per the guidelines in this section.

6 Installing the Fire Pit

Fuel line

- Fire pit must have a gas shutoff on the outside of the exterior of the fire pit to allow for emergency shut off and maintenance. The gas shutoff should not be used to adjust flame height.
- The installer is responsible for using the correct fuel line sizing that is able to supply the stated maximum BTU for the product – refer to product label on the fire pit for specifications.

INSTALLATION

We suggest that our products be installed by professionals that are locally licensed by the authority having jurisdiction in gas piping.

- Perform all leak tests with leak detector or leak reactant.

IMPORTANT

To prevent damage, unhook the fire pit from the gas supply for pressure leak tests of the supply line.

IMPORTANT

***Burn Testing:* It is the responsibility of the qualified installer to test for gas leaks at all connections.**

IMPORTANT

***Gas Plumbing Connections:* Use joint compound or tape that is resistant to all gases. Apply joint compound only to all male pipe fittings. **DO NOT use on flex line flared fittings.** Be sure to tighten every joint securely.**

Installation Steps:

1. Set fire pit in properly constructed enclosure, read **Section 5 – Fire Pit Enclosure Requirements**.
2. Position fire pit following safety recommendations with access to all gas connections for testing. Read **Section 3 – Selecting the Fire Pit Location** for more details.
3. Shut off gas supply to fire pit.
4. Attach antenna extension cable as explained on page 15.
5. Connect proper 120 VAC or 24 VAC electrical power following all local codes.
6. Connect fire pit to main gas supply. Warning: avoid sharp bends with flex line to prevent whistling.

6 Installing the Fire Pit

7. Turn on gas supply, purge gas lines of air and perform leak test on all inlet connections. Repair as needed.
8. Initial Start-up after install:
Several "ON/OFF" cycles may be necessary to purge air in gas lines after system installation.
 1. Turn "ON" electrical power to fire pit via wall switch or breaker.
 2. Turn "ON" gas to fire pit.
 3. Remove Blowout Box lid to allow viewing of hot surface igniter.
 4. Pointing remote control towards antenna, press and release the Power ON/OFF button, Figure 6.1.
NOTE: Remote Control LED- 2 flashes indicates signal received.
 5. Hot surface igniter should begin to glow within 10 seconds.
 6. Pilot flame will eventually igniter. NOTE: This may take several cycles due to air in the gas line. Unit will lockout after 15 cycles- to reset, please turn "OFF" electrical power using wall switch or breaker then turn "ON", repeat step 4.
 7. Main burner will igniter.
 8. Pointing remote control towards antenna- test High/Low function.

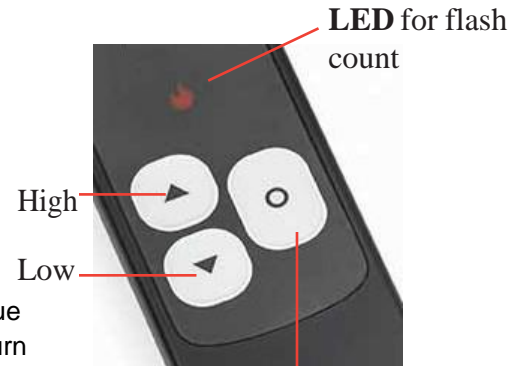

Figure 6.1 – Remote.

Power On/Off

IMPORTANT

Remote Control LED- 8 or 10 flashes indicate signal not received. PLEASE CONFIRM ANTENNA IS MOUNTED OUTSIDE ENCLOSURE AND ANTENNA/MINI-COAX CABLE CONNECTIONS ARE TIGHT, and then repeat steps above.

9. Once fire pit is lit, perform leak test on all gas connections. Repair as needed.

IMPORTANT

For Penta Burner inserts, flame will be smaller with no media on the burner.

10. Turn off fire pit and allow it to cool.
11. Apply media as described in **Section 7, Adding Approved Media**. When filling the pan with lava rock and/or decorative glass, the instructions in Section 7 must be followed.
12. Turn on fire pit again and perform leak test with media correctly installed. If gas leak is detected verify correct media application and repair as needed.
13. Verify correct operation and lighting.
14. Review safety manual with end-user. Instruct end-user that fire pit or media must not be changed or modified.
15. Leave manual with end user.
16. Apply the Start Up and Shutdown decal next to control box in an obvious and highly visible position.

6 Installing the Fire Pit

Antenna Extension Cable Mounting

Begin by deciding where the antenna bracket will be installed, depending on the type of enclosure, Figure 6.2.

- Antenna must be installed on the outside of the enclosure.
- Place antenna on side where most usage will occur.
- Install as high up on the enclosure but below top surface.

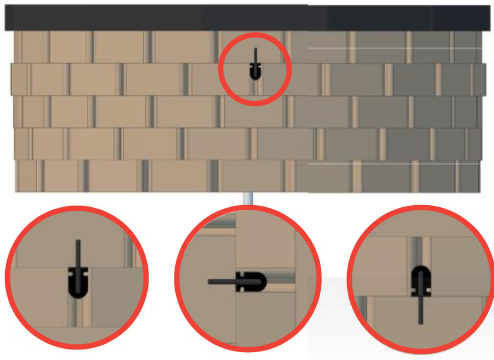

Figure 6.2 – Antenna placement

Enclosure with a cap

1. Plot the hole locations that will be drilled to fasten the antenna bracket. See Figure 6.3.

NOTE: The two smaller holes are for fastening the bracket and the one larger hole is for the antenna cable to slide through. When drilling holes, ensure there is no debris and that the antenna cable hole is large enough to not damage the antenna cable.

2. Drill hole for antenna using the proper drill bits depending on the type of finish on the enclosure.
 - The recommended hole size for the antenna is 3/8" (.375").
3. After drilling, dry fit the bracket while sliding the antenna bracket into the enclosure. Figure 6.4
 - Mark holes for fastening bracket to enclosure
 - Drill holes for fasteners
4. Fasten down the bracket by using proper fasteners depending on the type of finish on the enclosure, Figure 6.5.
 - Example: For brick finish use Tapcon® screws.
5. Attach antenna cable end onto the valve box being careful not to damage center pin, lightly tighten with wrench to ensure connection. Figure 6.6.

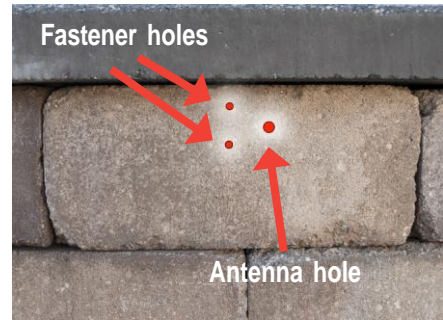

Figure 6.3 – Plot the hole locations



Figure 6.4 – Dry fit the bracket



Figure 6.5 – Fasten down the bracket



Figure 6.6 – Attach antenna cable

6 Installing the Fire Pit

Enclosure without cap

1. Plot the hole locations that will be drilled to fasten the antenna bracket.

NOTE: The two smaller holes are for fastening the bracket and the one larger hole is for the antenna cable to slide through. When drilling holes, ensure there is no debris and that the antenna cable hole is large enough to not damage the antenna cable.

2. Drill hole for antenna using the proper drill bits depending on the type of finish on the enclosure.

- The recommended hole size for the antenna is 3/8" (.375").

3. After drilling, dry fit the bracket while sliding the antenna bracket into the enclosure. Figure 6.8.

- Mark holes for fastening bracket to enclosure
- Drill holes for fasteners

4. Fasten down the bracket by using proper fasteners depending on the type of finish on the enclosures, Figure 6.9.

- Example: For brick finish use Tapcon® screws.

5. Attach antenna cable end onto the valve box being careful not to damage center pin, lightly tighten with wrench to ensure connection. Figure 6.10.

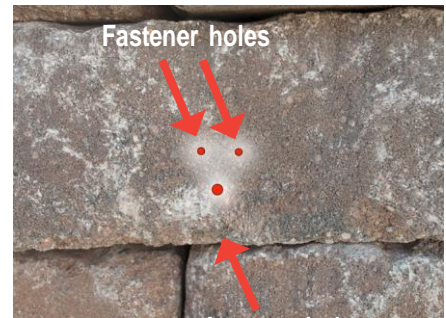

Figure 6.7 – Plot the hole locations



Figure 6.8 – Dry fit the bracket



Figure 6.9 – Fasten down the bracket

Attach antenna extension cable here



Figure 6.10 – Attach antenna cable

7 Adding Approved Media

WARNING

FOR GLASS MEDIA USAGE WITH LP GAS - WHEN USING APPROVED DECORATIVE GLASS TO COVER BURNER APPLY ONLY ENOUGH TO HIDE BURNER. APPLYING OVER 1/2" MAY CREATE BACK PRESSURE AND GAS LEAKAGE FROM AIR MIXER RESULTING IN LP POOLING UNDER FIRE PIT.

WARNING

FOR GLASS MEDIA USAGE WITH LP GAS - THE UNIT MUST BE TESTED WITH MEDIA OVER BURNER FOR CONFIRMATION OF NO BACK PRESSURE CREATING GAS TO LEAK OUT OF AIR MIXER VENTURI HOLES. THIS MAY HAVE TO BE DONE PRIOR TO PLACING IN ENCLOSURE IF NO ACCESS DOOR.

WARNING

Never use any material that is non-porous or holds moisture such as gravel, pebbles, river rock, etc. When heated, non-porous material will not allow heated steam to readily escape which can break and cause personal injury or damage. Material that holds moisture can boil and fracture unexpectedly when exposed to heat.

IMPORTANT

The fire pit is designed to use approved media correctly installed over the burner to achieve proper combustion.

- Never install a mesh or screen under the media.
- Media affects flame pattern greatly. It is possible to create an unusual flame pattern that could damage your enclosure. Enclosure damage from an open flame fire feature is not covered under any warranty.
- The use of concrete logs is not recommended.







7 Adding Approved Media

Application of Approved Media

Please follow the instructions below to add the finishing touch to your fire pit.

Particular attention needs to be on the pilot assembly area.

Incorrect media installation will cause the pilot flame to suffocate and turn off pit or delay main burner ignition.

Lava Rock Only Application	Decorative Glass Application
<p>1) Install your fire pit per instructions.</p>  <p>2) Apply lava rock ONLY deep enough to cover ring.</p>  <p>3) Blowout Box: Leave vents open. Do not cover vents with lava rock or allow any rock to block flame opening. Incorrect media installation will cause the pilot flame to suffocate and turn off pit or delay main burner ignition.</p>  <p>Do not cover box vents!</p>	<p>1) Install your fire pit per instructions.</p>  <p>2) Fill pan with media. Cover burner with 1/4 to 1/2 inches of glass. Do not overfill pan with glass. All LP installations must be checked for back pressure with media installed. Failure to do so may result in personal injury or property damage.</p>  <p>3) Blowout Box: Do not cover blowout box vents or opening with glass. Incorrect media installation will cause the pilot flame to suffocate and turn off pit or delay main burner ignition.</p>  <p>Do not cover box vents!</p>

8 Operating the Fire Pit

- Before use, be sure to test all gas connections for leaks. Do not use fire pit if there is any evidence of leaking gas. If leaking gas suspected, turn off the main gas supply and repair immediately.
- Do not use the enclosure as a seating area. Wind and gusty conditions will affect the flame in an unpredictable manner. If conditions exist that are not safe for patrons, turn off the fire pit.
- The hose should be inspected before each use of the fire pit and replaced prior to use if there is evidence of excessive abrasion or wear or if the hose is damaged. The replacement hose assembly shall be that specified by the manufacturer.
- Do not use the fire pit if any part has been under water. Immediately call a qualified service technician to inspect the fire pit and to replace any part of the control system and any gas control that has been under water.
- Never use any material that is non-porous and holds moisture such as gravel, pebbles, river rock, etc. This material, when heated will cause the trapped moisture to boil and fracture unexpectedly. This material is not sufficiently porous to allow heated steam to readily escape which can break and cause personal injury or damage.
- Solid fuels shall not be burned in the fire pit.
- Leaves, sticks, wood, paper, clothing, food material, should be kept away from the fire pit. Clothing or other flammable materials should not be hung from the appliance or placed on or near the appliance. Keep the appliance area free from gasoline, and other flammable vapors and liquids.
- Fire pit is not for cooking.
- Make sure that there is no vegetation or other objects over the top or sides of the fire pit that could interfere with safe operation. See clearances in **Section 3 – Selecting the Fire Pit Location**.
- If lava rock is wet, allow the fire pit to burn for 45 minutes prior to coming within 15 feet of the fire pit.
- When the fire pit is not in operation, turn off gas valve.
- When not in use, the fire pit must be covered at all times.

8 Operating the Fire Pit

Start-up

Initial Start-up: Several “ON/OFF” cycles may be necessary to purge air in gas lines after system installation. Fire pit will lockout after 15 attempts to light pilot, please power OFF then ON to restart. See Page 14.

Sequence of Operation:

1. The igniter will be powered (glow red) for five seconds before pilot valve opens.
2. The igniter will only be powered the initial 15 seconds of the 30-second pilot cycle. This sequence will repeat up to 15 times (approximately 15 minutes) before going into lockout. To reset, turn “OFF” main power to fire pit then back “ON” again.
3. Pilot flame will ignite and warm thermocouple; it may take 30 seconds at times for thermocouple to get hot. If thermocouple is not hot in 60 seconds, system will shut down. If this occurs, go back to Step 1.
4. Once thermocouple is hot, main valve will open allowing main burner to ignite.
5. If pilot flame is blown out at any time, system will shut down, and then automatically restart (Step 1).



DANGER

If you smell gas:

- 1) Shut off gas to appliance.
- 2) Extinguish any open flame.
- 3) If odor continues, keep away from appliance and immediately call gas supplier or fire department.

EI Fire Pit Start Up- Bluetooth HI/LOW

1. **STOP! Read the safety information on “What to Do If Smell Gas” (Pg. 1).**
2. Confirm there is no debris in the fire pit (as mentioned in warnings) including water.
3. Turn “ON” electrical power via wall switch or breaker and gas to fire pit.
4. Use remote to turn “ON” fire pit - this may take several cycles control to purge any air.
5. To reset after lockout, power unit down, wait 5 minutes, then restart.
6. Once the fire pit has ignited **DO NOT** leave unattended.

This product is not for use with small tanks.

EI Fire Pit Shutdown

1. Turn “OFF” fire pit using remote, wall switch or app.

IMPORTANT

FOR REMOTE CONTROL USE, YOU MUST ALSO TURN OFF POWER TO ELECTRICAL OUTLET OR GAS TO FIRE PIT TO PREVENT ACCIDENTAL START.

2. Once fire pit is cooled, use appropriate cover to protect fire pit.

8 Operating the Fire Pit

The following sections explain operation of:

A. Remote control B. Smartphone control

A. HPC Remote Control – After turning ON the gas to fire pit, operate as follows:

1. **Normal Remote Operation** – Figure 8.1

- a. Power ON/OFF – 2 Flash
- b. High – 4 Flash
- c. Low – 3 Flash
- d. Poor Communication – 10 Flash (Move closer or change positions.)
- e. Remote Response Time – When not in use for more than 30 seconds, the remote will go into a sleep mode to save battery life. If remote is in sleep mode it may take a few extra seconds for a command to be executed.

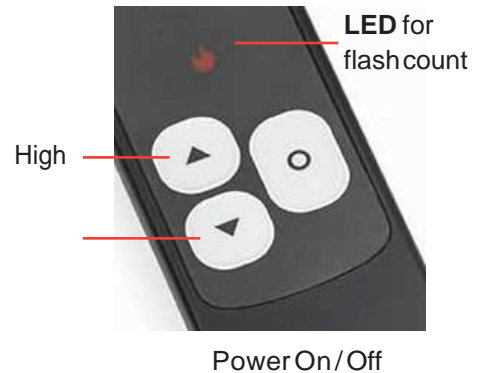

Figure 8.1

2. **Remote sync** – The remote should arrive already synced to the fire pit. Figure 8.2

- a. If you need to sync the remote to a fire pit:
 - 1. Ensure power is OFF to fire pit.
 - 2. Depress the LOW and OFF button simultaneously and hold until the remote flashes rapidly (8 to 10 seconds)
 - 3. Release the LOW and OFF buttons
 - 4. Apply power to the fire pit within 10 seconds – Fire pit will accept a new remote for the first 60 minutes it is on.
 - 5. Allow the remote to finish flashing which could take up to 30 seconds
 - 6. Your remote should operate the fire pit



Figure 8.2

NOTE: If steps 5 or 6 fail, please repeat Steps 1 through 7. Also confirm antenna placement, see **Section 6 – Installing the Fire Pit.**

8 Operating the Fire Pit

3. **Remote Range** – The remote should reliably operate within a 25-foot distance from your fire pit. Greater distances may be possible depending on your particular application. Antenna extension cable is available when needed. See Figure 8.3.

- a. Metal objects negatively affect communication between the remote device and your fire pit. Objects such as metal enclosures, metal grates and metal mesh for stone veneer or in some cases metal furniture may interfere with communication between your remote device and the fire pit.

4. **For lost remote** – If the remote is misplaced, the fire pit may still be turned on by the following method:

- a. Apply power for 5 seconds; turn off for at least 5 seconds. (Repeat three times, all times for +/- 1 second).
- b. Next time unit is powered up it will turn ON. Fire pit can still be turned off with the remote. Once power is removed, start over with step a.

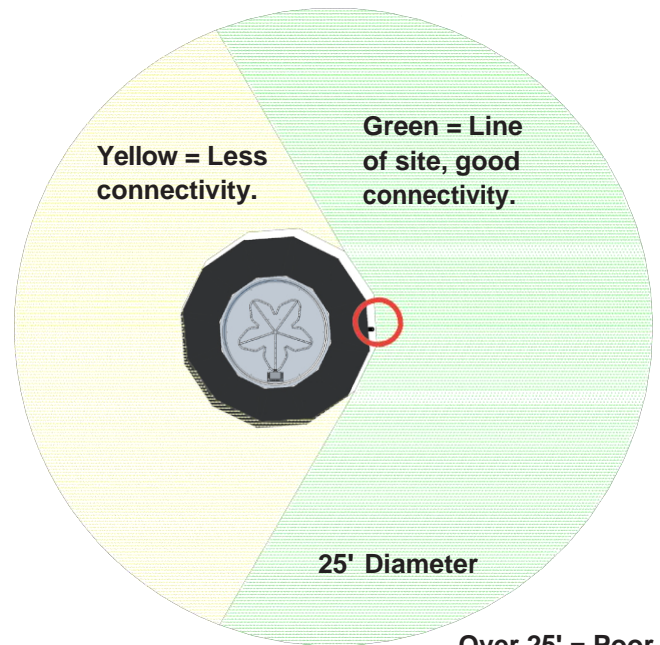

Figure 8.3 – Antenna range

IMPORTANT

If power to the fire pit is turned off, then immediately turned back on, the system will go into lockout mode. To reset, turn off, wait five minutes, then turn back on.

B. Smartphone Control – After turning ON gas to follow the app instructions document. Figure 8.4



Figure 8.4 – Smart phone control

8 Operating the Fire Pit

El app Instructions

App setup and usage

NOTE:

- The content of the app or the design is subject to change. Support for apps may be discontinued without notice, depending on the content provider’s policy.
- Adult use only.

ATTENTION:

- When pairing a device with the fire pit, only one Bluetooth® connection can be used. Turn Bluetooth “OFF” to allow other devices to connect to the fire pit.

Setting up the App:

1. Download the HPC Fire app from the  Apple store or Google Play.
2. If power to the fire pit is already applied, disconnect power for 20 seconds and reconnect power.
3. Open the HPC Fire app, Figure 8.5.
4. From the home screen, enter 6 characters; this is your login name or security key, Figure 8.5.
5. Confirm the security key and type login name again, Figure 8.5.
6. Select your language, and press “Continue”.
7. Enable the Bluetooth and return to the HPC Fire app, Figure 8.6. If prompted to allow access to your files and location – tap Allow

NOTE: For Apple devices accept the pairing request.

8. Tap on Fire Pit 1, Figure 8.7.
9. Enter the default security code 2345 and press “Connect”, Figure 8.8. Repeat until app is connected to the fire pit.

NOTE: If app will not pair with the fire pit, disconnect power for 20 seconds and exit the app, and then repeat the install steps above.



Figure 8.5

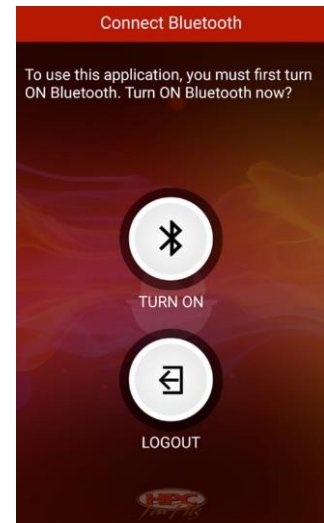

Figure 8.6

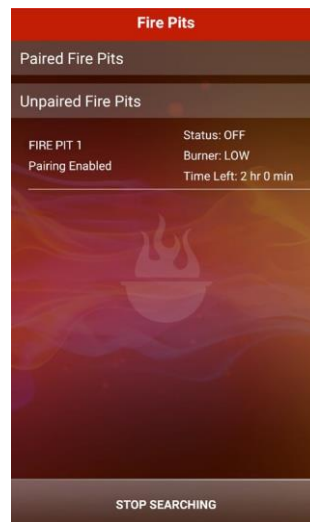

Figure 8.7

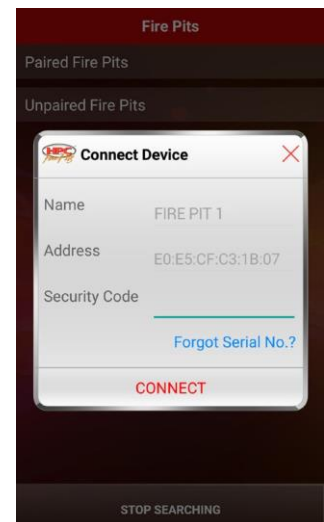
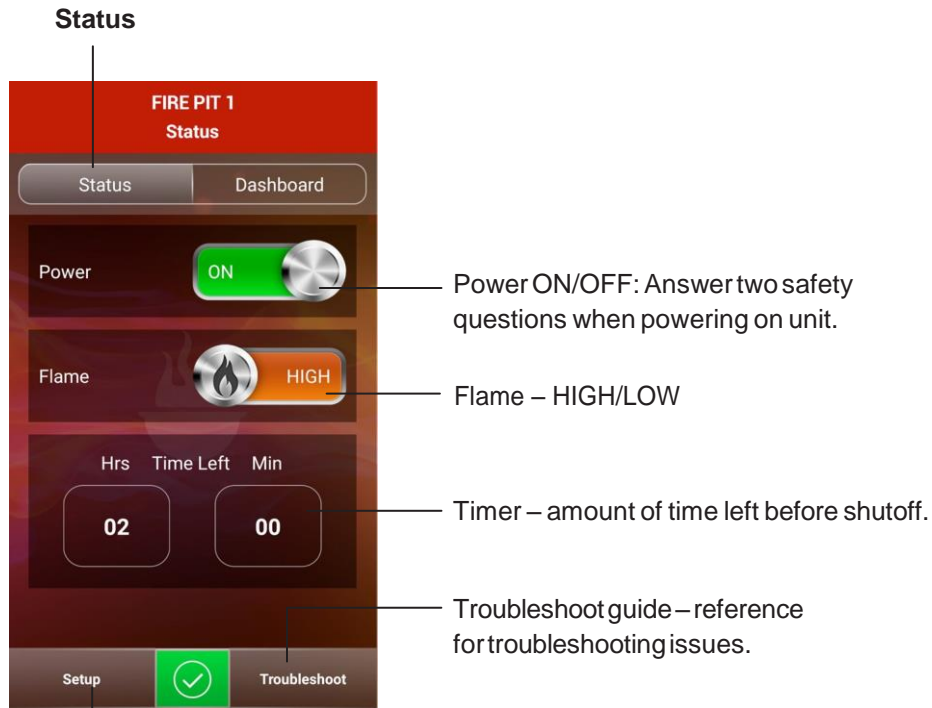

Figure 8.8

8 Operating the Fire Pit



Power ON/OFF: Answer two safety questions when powering on unit.

Flame – HIGH/LOW

Timer – amount of time left before shutoff.

Troubleshoot guide – reference for troubleshooting issues.

- Setup –
1. Timer ON/OFF and set the timer.
 2. Customize the fire pit's name.
 3. Customize the security code.

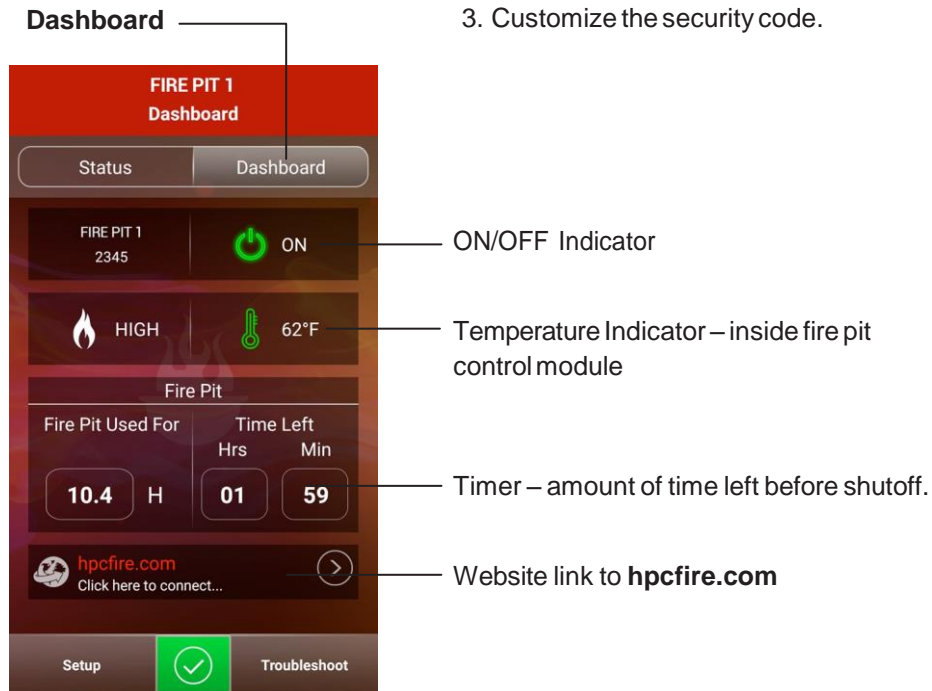

ON/OFF Indicator

Temperature Indicator – inside fire pit control module

Timer – amount of time left before shutoff.

Website link to hpcfire.com

9 Maintaining the Fire Pit

- Any guard or protective device removed for servicing must be replaced prior to operating the fire pit.
- We suggest that our products be serviced annually by a professional certified in the US by the National Fireplace Institute (NFI) as NFI Gas Specialists.
- Ensure gas is shut off and fire pit is cool before servicing.
- Keep fire pit covered at all times when not in use and free of debris.
- In some areas of the country, spiders or insects have been known to build nests and/or lay eggs in the venturi holes of the air-mixer for LP units. This can cause fuel to fill the fire feature cavity and result in personal injury or property damage. Periodic inspection by a qualified service technician of the air-mixer is required to ensure your fire feature performs properly, Figure 9.1.
- **Burner Cleaning: One time a year.** If flames exhibit any abnormal shapes or behavior, or if burner fails to ignite properly, then the burner holes may require cleaning. The appliance can be cleaned by carefully removing the logs and media to allow access to burner. Use a brush to carefully remove dust, spider webs, and loose particles from base, logs, and fire ring itself. If evidence of damage, fire ring must be replaced with fire ring specified by the manufacturer.
- **Thermocouple cleaning of soot: Once every six months or as needed.** Remove lava rock & glass around pilot, then the blowout box lid. Clean thermocouple of any soot using soft brush. Be careful not to damage hot wire element. Place lava rock or glass back as explained in **Section 7 – Adding Approved Media.**
- Always ensure that the union fitting is tight. If loose, torque until there is no leak (recommended torque value of 80 ft lb).
- **Visually inspect the pilot.** The pilot flame should cover 3/8 inch to 1/2 inch of the thermocouple, Figure 9.2. Cleaning of the pilot orifice may be required by removing pilot hood counter clockwise and removing orifice, Figure 9.3.

Service



We suggest that our products be serviced by a professional certified in the US by the National Fireplace Institute (NFI) as NFI Gas Specialists.



Figure 9.1 – Locating orifice for cleaning



Figure 9.2 – Pilot flame coverage of thermocouple.



Figure 9.3 – Cleaning pilot orifice

10 Troubleshooting

Table 10.1, below indicates some potential causes and countermeasures to the symptoms indicated in bold type. **Please contact your retailer or certified technician for service and repair.**

- The error number and description are shown in the troubleshooting tab in the app or the number of blinks on the remote.
- For Override Start Up Mode see next page

Service



We suggest that our products be serviced by a professional certified in the US by the National Fireplace Institute (NFI) as NFI Gas Specialists.

Error Number & Description	Problem	Possible Causes	Solution
1 Igniter failure 6 Igniter open	Pilot Will Not Light	Air in gas line	New install – May take several attempts
		No gas flow – Gas not ON or line obstruction	Confirm gas is ON upstream Possible debris in line – insulation, dirt, plastic, etc.
		Pilot orifice dirty or clogged	Remove orifice and clean (Section 9)
		Gas pressure improper	Confirm proper gas pressure (Section 1)
		Igniter element damaged	Change igniter element
		Damaged wires	Inspect wires to igniter. Confirm insulation is in good condition and connections are tight
3 Thermocouple error 4 Hardware fault 5 Flame at startup	No Main Burner (Pilot Flame Present)	Loose thermocouple at valve box	Tighten down connection at valve box. Should be tightly snug.
		Thermocouple cracked/broke under pilot assembly	Replace thermocouple
		Gas pressure improper	Confirm proper gas pressure (Section 1)
		Small pilot flame	Remove pilot head and clean orifice (Section 9)
		Dirty thermocouple	Clean using soft brush
		Fire ring obstructed	Confirm no debris or water in ring
		Improperly applied media	See Section 7.
		Pilot flame present at all times	Possible debris inside valve
Main Burner Turning Off/On Frequently	Main Burner Turning Off/On Frequently	Small pilot flame	Remove pilot head and clean orifice (Section 9)
		Improperly applied media	See Section 7.
		Gas pressure improper	Gas pressure too low (Section 1)
		Thermocouple defective	Change thermocouple
2 Over temperature 7 Broken communication 8 Not paired 9 Out of range 10 Internal control fault or Over temperature	No Power or Response from Unit	No power to unit	Confirm breaker, wall switch and remote are on
		Remote not working	Change batteries
			Re-sync remote (High/Low models only)
		Has power to unit but will not cycle	Check external fuse (5A)
			Check voltage to unit Module sensing wrong voltage. Replace module and transformer
		Over temperature	Inadequate venting see proper venting in Section 5. Power OFF then back ON to reset
		Has power to unit but remote or app will not communicate	Reconnect by pairing to unit, power unit OFF then back ON at power supply to reset.
			Out of range, move closer to unit to allow communication and ensure align of sight
			Transceiver not communicating with module. Check communication cable and ensure indicator light on transceiver is on.

Table 10.1 – Troubleshooting

10 Troubleshooting

Override Start Up Mode

In the event of lost or damaged remote control / smart device or poor Bluetooth connection, the fire pit may be temporarily started in the Override Start Up mode using a unique sequence of applying supplied power "ON" & "OFF".

Override Start Up:

The power application sequence is as follows using a wall switch, breaker or unplugging power cord:

1. Supplied Power is "OFF" to fire pit.
2. Power "ON"- 5 seconds exactly.
3. Power "OFF"-2 seconds exactly.
4. Repeat Steps 2 & 3- two more times.

Power & leave "ON". The fire pit will eventually start and operate at the default HIGH setting only.

*Please note the remote control or smart device will not function in this mode.

Shut Down:

1. To turn "OFF" fire pit, please turn "OFF" supplied power.

11 Wiring Diagram

120VAC Models:

(Included in fire pit control box)

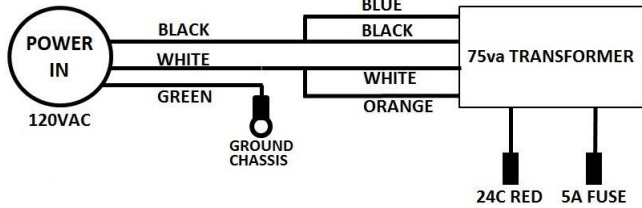

24VAC Models:

(Power supply sold separately)
311-PS1, 311-PS3, 311-PS5

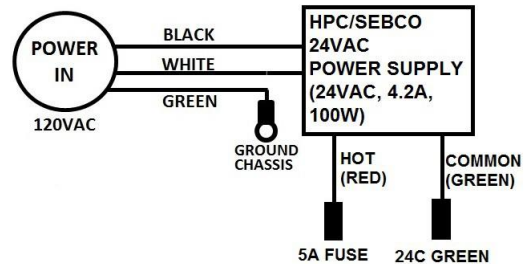

NOTE: 100W Output Required

Both Models:

All wire - 18 AWG, °200C, 600V
1/4" fully insulated female spade terminal, 22-16 AWG 250a, x 11 (color red)
#6 Ringlet Terminal 22-16 AWG
Zip tie - Nylon 66 UV stable miniature, 3" length

HPC EI WIRE DIAGRAM
120VAC / 24v

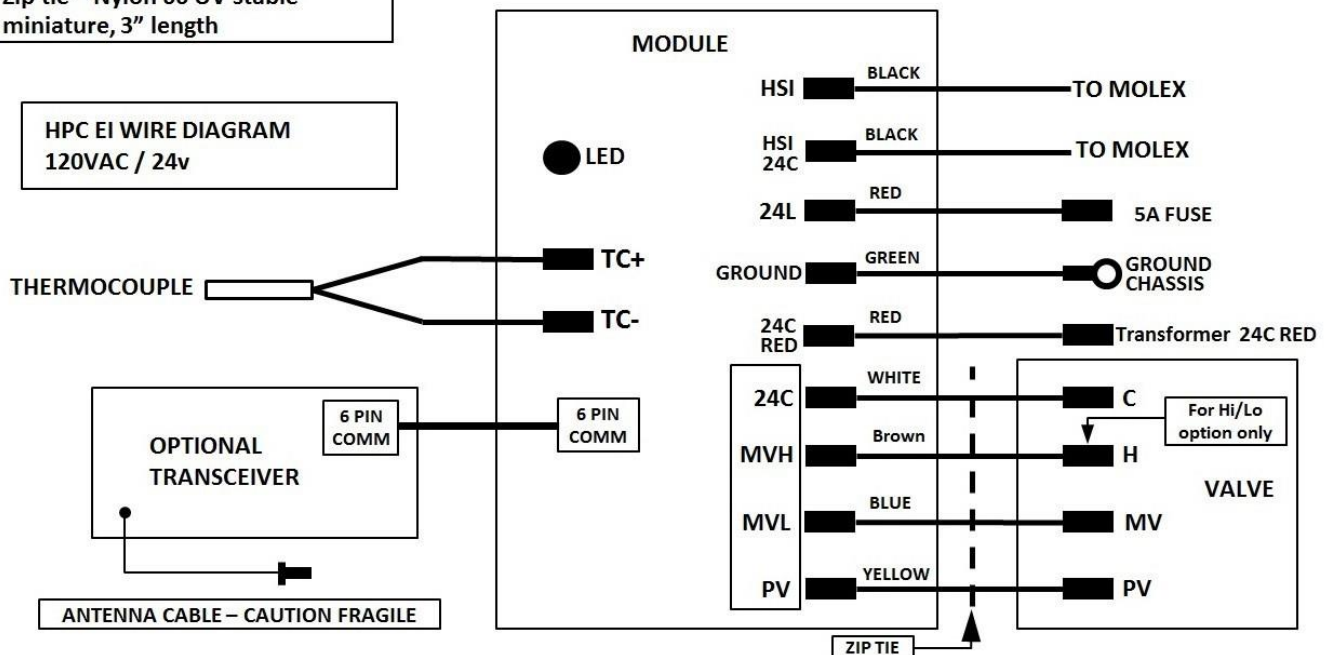

12 Compatible Accessories

- **Wind guards** – Clear glass wind guards protect flames from being blown out in windy conditions as well as personal belongings from being blown into the fire. Available in round, linear and square shapes. See Figure 12.1.
- **Fire pit cover** – Hearth Products Controls has decorative copper covers and heavy-duty vinyl covers for your fire pit that will protect it from rain, snow, and moisture. See Figure 12.2.

For a complete list of accessories, visit www.hpcfire.com



Figure 12.1 – Wind guard



Figure 12.2 – Fire pit cover

13 Replacement Parts

Please contact your dealer for parts – if unsure please contact HPC or visit our website at www.hpcfire.com and we will be happy to help you.

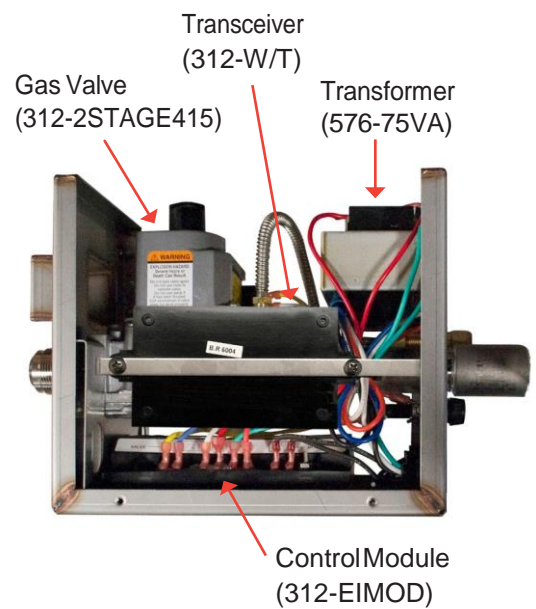
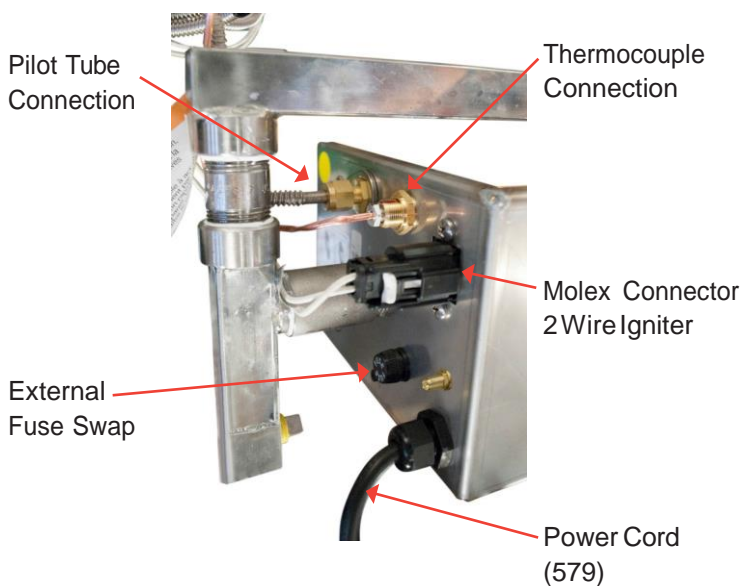

13 Replacement Parts

Antenna Extension
(AEK-60HI/LO)

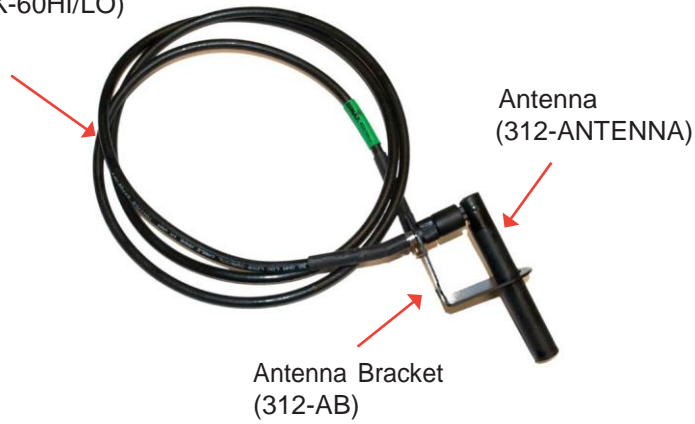

Pilot Assembly

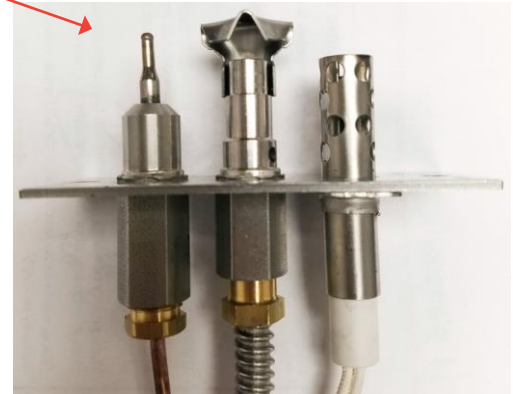

EI Series Replacement Components

Part Number	Item
311-T/C	Thermocouple
312-IGNITER	Hot Surface Igniter
312-EIMOD	Control Module
312-2STAGE415	Gas Valve
576-75VA	Transformer
579	120VAC Power Cord
Please Buy Local	Fuse (5A) – common fast acting
312-W/T	Transceiver
312-REMOTE	Remote Control
312-AB	Antenna Bracket
312-ANTENNA	Antenna
AEK-60HI/LO	Antenna Extension

Pilot Assembly

Part Number	Fire Pit Size	Gas
HSIP-36SS	50k ~ 275k BTU	NG
HSIP-36SS-300NG	300k BTU	NG
HSIP-36SS-400NG	400k BTU	NG
HSIP-36SS-50/225LP	50k ~ 225k BTU	LP
HSIP-36SS-250 / 400LP	250k ~ 400k BTU	LP

14 Warranty

Warranty

Hearth Products Controls Co. (HPC) warrants fire pits against manufacturing defects that prevent safe and correct function as follows:

1) **Stainless Steel Fire Pit and Outdoor Fireplace Burners - Lifetime Warranty**

Limited Warranty:

- 2) Electronics, Gas Valve: Commercial-1 year; Residential-3 year.
- 3) Pilot Assembly: Commercial-1 year; Residential-2 year.
- 4) Stainless Steel Pan, Valve Box: Commercial-1 year; Residential-5 years

Warranty commences from the date of original sale / shipment from HPC FOB Dayton, Ohio. This warranty is for parts and in-house (HPC) labor. The defective product must be sent back to HPC with a Return Merchandise Authorization (RMA) issued by HPC for that specific product and any other additional information for the nature of the defect or warranty claim. The warranty does not cover items that have been damaged by overheating, modification, abuse, or improper storage. Also any labor involving installation or maintenance with the unit is not covered. This warranty excludes claims for consequential, indirect-collateral expenses arising from product defects or warranty recovery.

Rev.0 5/8/2019



Fire-inspired since 1975.

3050 Plainfield Road
Kettering, Ohio 45432

For detailed product information, go to www.hpcfire.com