



MODERN  FLAMES

2020

Traditional Catalog

Electric Fireplaces • Electric Inserts • Electric Log Sets

# MODERN FLAMES



## ABOUT US

Modern Flames was established in 2008 and has quickly become the innovative leader in contemporary electric fireplace design and technology. After pioneering the linear electric fireplace throughout North America, Modern Flames' brand has skyrocketed with many firsts to market which include; the first linear recessed electric fireplace, the first fully built-in electric fireplace, the first outdoor electric and now the first steam electric fireplace. Modern Flames has reinvented the electric fireplace look with its NEW Hybrid-FX™ flame technology. Modern Flames' products have gained notoriety with architects, designers, builders and homeowners for its

unbelievable life-like flame appearance, ease of installation and affordable cost to the builder compared to wood and gas. With global movement into greener building and high efficiency products, Modern Flames' new FusionFire™ technology allows consumers to achieve the look of a fireplace without sacrificing the realism of a real fire. With a new corporate headquarters and expanded warehouse in Phoenix, Arizona, along with its new steam technology, Modern Flames continues to be a leader in the electric fireplace industry. Modern Flames is innovating the industry standards of tomorrow.

## CONTENTS

### 4-7 Sedona Pro™ Multi Series

Multi Sided Views with Multiple Installation Configs

### 8-13 RedStone Series

Built-in Flush Mount Electric Fireplace Insert

### 14-15 Sunset Charred Oak Logs

Electric Log Set - Li-ion Battery or Plug-in

COVER PHOTO

Hybrid-FX™  
FLAME TECHNOLOGY  
RedStone 36"



Sedona Pro™ Multi 36"

# SEDONA PRO™ MULTI SERIES

## Multi Sided Electric Fireplace











- MULTI SIZES: 30", 36" & 42"
- MULTI INSTALL DEPTHS: BUILT-IN CLEAN FACE - PARTIAL 2x6 RECESS
- MULTI CONFIGURATIONS: SINGLE SIDED, LEFT CORNER, RIGHT CORNER & 3-SIDED (BAY)
- MULTI LIGHT CONTROL: FLAME COLOR, EMBER BED COLOR & DOWNLIGHTING COLOR
- MULTI LIGHT COLORS: FULL RGB COLOR SPECTRUM IN ALL LIGHTING FEATURES

*Choose a beautiful single sided installation or get creative and design the fireplace exactly how you want into the feature wall of your dreams. New high intensity multi-color flame technology paired with matching up lighting and downlighting create the full customizable experience in the home. Hundreds of different stunning color combinations to select from!*



Sedona Pro™ Multi 36"

### STANDARD FEATURES

-  Hybrid-FX™ Flame Technology
-  Back Flame & Ember Bed Controlled Independently or Together  
Down lighting
-  2 Different Ember Bed Stone Styles
-  Full Flame Viewing Area
-  Fully Finished Clean Face Installation
-  5,000 BTU Variable Heater
-  Variable Flames
-  Remote Control
-  Hidden Manual Controls
-  Wi-Fi Controls with Modern Flames App

# SEDONA - INDEPENDENT COLOR CONTROL

Full Color Spectrum Lighting for Flames, Ember Bed & Downlighting



# MEDIA - PREMIUM LOG SET STANDARD

Canyon Driftwood Log Set with Smoked Glacier Glass Ember Bed

# UPGRADE MEDIA

Cannon Ball Media



Cannon Balls - Available Sizes: 2", 4" & 6" (4" shown)

# HEAT - 5,000 BTU

120V & 240V High Efficiency Ceramic Heater



FLAMES & LIGHTING  
15 WATTS  
NO HEAT



1500 WATT HEATER  
120V 5,000 BTU  
UP TO 400 SQ FT



Sedona Pro™ Multi Fireplaces are equipped with adjustable heaters controlled by remote or phone app. Wall Tether has thermostat controls.

# STANDARD CONTROLS

REMOTE CONTROL & MANUAL CONTROL



MODERN FLAMES

FULL FEATURED  
WiFi APP



# UPGRADE CONTROL

WIRELESS WALL TETHER WITH  
THERMOSTAT CONTROL



# MULTI INSTALLATIONS - OVER 12 DIFFERENT CONFIGURATIONS

- BUILT-IN/ CLEAN FACE INSTALLATION
- PARTIAL RECESS INSTALLATION (2x6 WALL)
- FLOATING WALL CABINET
- FLOOR CABINET
- SINGLE SIDED
- LEFT CORNER
- RIGHT CORNER

SINGLE SIDED

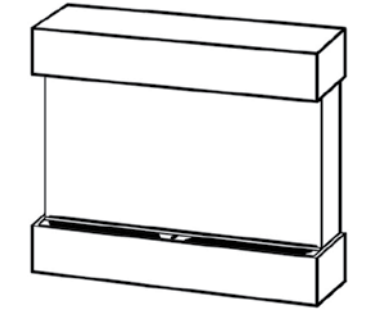
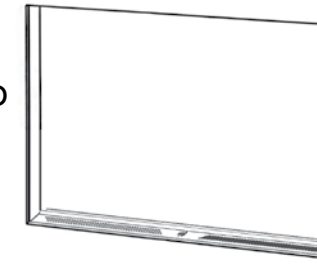

2x6  
RECESS

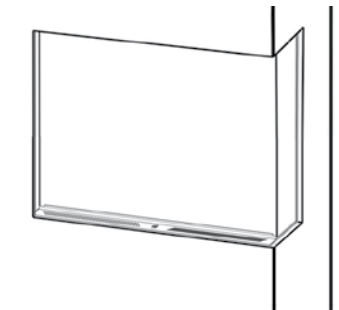

RIGHT CORNER

# SEDONA PRO™ MULTI DIMENSIONAL SPECS

MODEL #	MODEL & CONFIGURATION	VIEWING AREA			FIREBOX DIMENSIONS					
		A FRONT GLASS WIDTH	B SIDE GLASS WIDTH	C GLASS HEIGHT	D OVERALL WIDTH	E OVERALL HEIGHT	F OVERALL DEPTH	G BOTTOM TO VIEWING	H TOP TO VIEWING	I BACK TO VIEWING
SPM-3026	SINGLE SIDED	29.875"	-	26"	30"	35"	11.5"	4.5"	4.5"	-
	CORNER (L/R)	29.875"	5	26"	30"	35"	11.5"	4.5"	4.5"	4.125"
	3-SIDED (BAY)	29.875"	5	26"	30"	35"	11.5"	4.5"	4.5"	4.125"
SPM-3626	SINGLE SIDED	35.875"	-	26"	36"	35"	11.5"	4.5"	4.5"	-
	CORNER (L/R)	35.875"	5	26"	36"	35"	11.5"	4.5"	4.5"	4.125"
	3-SIDED (BAY)	35.875"	5	26"	36"	35"	11.5"	4.5"	4.5"	4.125"
SPM-4226	SINGLE SIDED	41.875"	-	26"	42"	35"	11.5"	4.5"	4.5"	-
	CORNER (L/R)	41.875"	5	26"	42"	35"	11.5"	4.5"	4.5"	4.125"
	3-SIDED (BAY)	41.875"	5	26"	42"	35"	11.5"	4.5"	4.5"	4.125"

# SEDONA PRO™ MULTI DIMENSIONAL DRAWING SHOWN BELOW

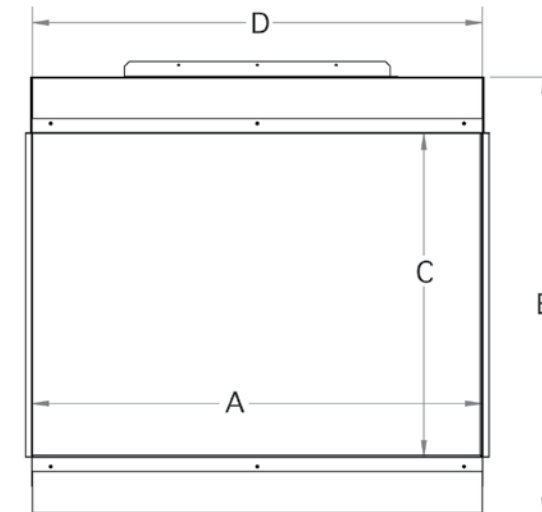

FRONT VIEW

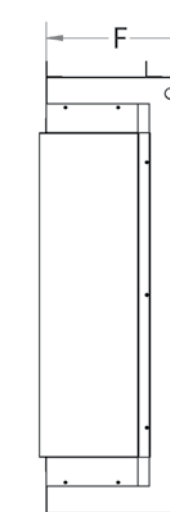

SIDE VIEW

LEFT CORNER

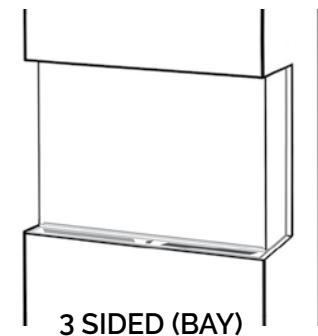
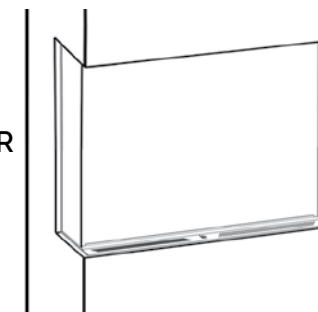

3 SIDED (BAY)



# REDSTONE SERIES













## Built-in Flush Mount Conventional Electric Fireplace

Modern Flames has revamped its built-in, flush mount conventional fireplace category with its new RedStone electric fireplace. The RedStone feature our new Hybrid-FX™ flame technology maximizing the flame height in an enlarged vertical viewing area. Some of the eye-catching features include high intensity RGB independently controlled up lighting, down lighting & flame color. Other standard features include 10 different unique colors to choose from, variable and thermostatically controlled heat, variable motor controls, timer, push button and remote controls. This conventional design can slide into an existing Zero Clearance wood burning fireplace or will need 10" of depth in a wall for the built-in flush mount look. The RedStone plugs into a standard outlet and includes a 5000 BTU heater. Acrylic crystal media and driftwood logs are both standard media & the RedStone is available in sizes 30", 36" & 42".



RedStone 36"

### STANDARD FEATURES

-  Hybrid-FX™ Flame Technology
-  10 Unique Flame Colors
-  Acrylic Crystal Ember Bed
-  Low Energy LED Flame Technology
-  Touch Button Controls
-  New Sleek Remote
-  Can be Installed Beneath a TV
-  Variable Heat with Thermostat
-  Variable Flame Controls
-  120 Volt Plug
-  Do it Yourself Installation Instructions
-  Finish Trim Kit Included

# REDSTONE SERIES

## Independent Flame & Ember Bed Color Combinations

The **6** button control panel is located at the top right on fireplace and includes a digital readout thermostat. From right to left, button **#1** turns the fireplace on or off. Button **#2** controls ember bed lights. **#3** controls the flame colors. Button **#4** turns the heater on or off. Button **#5** controls timer setting to turn off fireplace at selected time, and button **#6** adjusts the desired heater temperature.

### Flame & Ember Bed Colors Controlled Independently



Blue Flames - Logs on



Blue Flames - Logs off



Orange Flames - Logs on



Orange Flames - Logs off



Red Flames - Logs on



Red Flames - Logs off



Touch Button Control Panel



**REMOTE CONTROL INCLUDED**  
Separate controls for on/off variable heat and variable flame with independent flame and ember bed variable colors.

Full Color Spectrum Lighting for Flames, Ember Bed & Downlighting

### UPGRADE MEDIA



Cannon Balls - Available Sizes: 2", 4" & 6" (4" shown)

# REDSTONE SERIES

## Stoll Face Options

**STOLL FACES** are available in black or bronze, for RedStone 30".

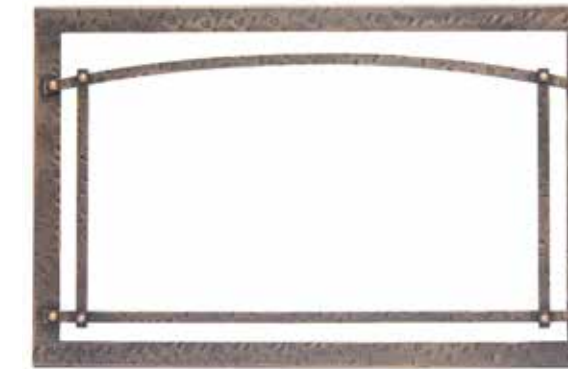

Stoll face shown in bronze.



RedStone 36"

# REDSTONE SERIES

## Dimension Specs

REDSTONE DIMENSIONAL SPECS

Model # of Fireplace	Trim Width	Part Number of Trim Kit	A	B
RS-3021	5/8in	Included with Fireplace	29-1/4in (743mm)	18-7/8in (479mm)
	1-5/8in	Included with Fireplace	31-1/4in (793mm)	20-7/8in (529mm)
	5in	TK-RS-3824	38in (965mm) (Thin trim on bottom)	23-1/4in (590mm) (Thin trim on bottom)
			38in (965mm) (Extra wide trim on bottom)	27-5/8in (701mm) (Extra wide trim on bottom)
	8in	TK-RS-4427	44in (1117mm) (Thin trim on bottom)	26-1/4in (590mm) (Thin trim on bottom)
			44in (1117mm) (Extra wide trim on bottom)	33-5/8in (853mm) (Extra wide trim on bottom)
RS-3626	5/8in	Included with Fireplace	33-3/4in (610mm)	24in (479mm)
	1-5/8in	Included with Fireplace	35-3/4in (907mm)	26in (660mm)
	4in	TK-RS-4128	40-1/2in (1,029mm) (Thin trim on bottom)	27-3/8in (695mm) (Thin trim on bottom)
			40-1/2in (1,029mm) (Extra wide trim on bottom)	30-3/4in (781mm) (Extra wide trim on bottom)
	6in	TK-RS-4530	44-1/2in (1,130mm) (Thin trim on bottom)	29-3/8in (746mm) (Thin trim on bottom)
			44-1/2in (1,130mm) (Extra wide trim on bottom)	34-3/4in (882mm) (Extra wide trim on bottom)
RS-4229	Not available	Not available		

\*5/8" trim included in box for built-in installations

## Built-In Trim Specs

RS-3021 • 5/8" trim



RS-3626 • 5/8" trim



RS-4229 • 5/8" trim



# REDSTONE SERIES

## Slide -In Trim Specs

RS-3021 • 1-5/8" trim



RS-3626 • 1-5/8" trim



RS-4229 • 1-5/8" trim



## Optional Insert Trim Specs

RS-3021

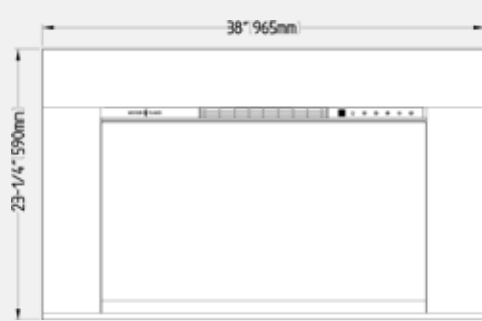

RS-3626

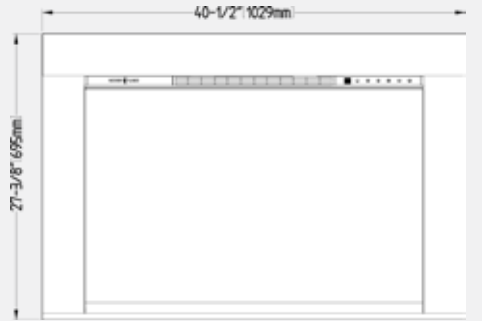

Model	A	B	Width	Part Number
RS-3021	38"	23-1/4"	5"	TK-RS-3824 - Thin Trim
RS-3021	38"	27-5/8"	5"	TK-RS-3824 - Extra Wide Trim
RS-3021	44"	26-1/4"	8"	TK-RS-4427 - Thin Trim
RS-3021	44"	33-5/8"	8"	TK-RS-4427 - Extra Wide Trim

Model	A	B	Width	Part Number
RS-3626	40-1/2"	27-3/8"	4"	TK-RS-4128 - Thin Trim
RS-3626	40-1/2"	30-3/4"	4"	TK-RS-4128 - Extra Wide Trim
RS-3626	44-1/2"	29-3/8"	6"	TK-RS-4530 - Thin Trim
RS-3626	44-1/2"	34-3/4"	6"	TK-RS-4530 - Extra Wide Trim



SCO-26

# SUNSET CHARRED OAK LOGS

## Electric Log Set

The Sunset Charred Oak Electric Logs set is the industries first battery powered and Wi-Fi enabled electric logs. This electric log set is designed to simply be unpackaged and installed into any existing wood burning fireplace without the hassle of running an electrical line. The Sunset Charred Oak features High Definition resin log detail, unsurpassed bark detail, 8 color paint scheme, Realistic LED ember bed, 6 stage lighting intensity and flame settings, hidden manual controls & Wi-Fi capability. Never has it been easier to add a full featured electric log set to your wood burning fireplace.











### HIGH DEFINITION RESIN LOG & BARK DETAIL



### OPTIONAL BATTERY PACK & CHARGER (10 hours of use)



### STANDARD FEATURES

-  High Definition Resin Log Detail
-  8 Color Log Paint Scheme
-  Realistic LED Ember Bed
-  6 Stage Lighting Intensity
-  Natural Flame Pattern
-  Hidden Manual Controls
-  Optional Lithium Ion Battery Pack
-  Wi-Fi Capability



SCO-20

26" LOG  
DIMENSIONS:  
12.25" Height  
25.5" Width  
13.5" Depth

20" LOG SET  
ALSO  
AVAILABLE

20" LOG  
DIMENSIONS:  
10" Height  
19.5" Width  
10" Depth



# MODERN FLAMES

ModernFlames.com

3515 E. Atlanta Ave. Phoenix, AZ 85040

(602) 268-9353 • (877) 246-9353



INNOVATING THE INDUSTRY STANDARDS OF TOMORROW