



Mont Alpi

Peak Performance

Grills



Mont Alpi

Peak Performance



Euro Style Eco Friendly GRANITE

MONT ALPI 805 ISLAND (MAI805)



- Six **304** Stainless Steel Burners.
- Ceramic Infrared Rear Burner,
- Ceramic Infrared Side Burner,
- Faux Granite Surfaces (White)
- All **304** Stainless Steel components,
- 8mm **304** Stainless Steel Cooking Grills,
- Warming Wrack **304** Stainless Steel,
- Main Cooking Surface excluding Warming rack 38" x 18",
- Arrives fully assembled
- 115,000 BTU Heat Output,
- Temperature Gauge
- Rotisserie Kit with Electric Motor (included),
- Bottle Opener
- Cast Iron Enameled Griddle plate (Not Included),
- Weather Cover (Not Included),
- Two Cooking Surface Halogen Lights,
- Control Knobs with Blue LED Lights,
- Electronic Ignition,
- Gliding Rubber Castor Wheels (2 with Brakes),
- Assembled Dimensions :
 - Grill unit 43x20x47",
 - Left Side Burner unit 25x20x35",
 - Right Side unit 25x20x35",
- Natural gas and Propane Ready.
- Propane Hose and Regulator included.
- Propane tank pull out for easy access
- Easy access grease trays for cleaning
- Large roller ball draws



MONT ALPI 400 ISLAND (MAI400)



- Four **304** Stainless Steel Burners.
- Ceramic Infrared Rear Burner,
- Ceramic Infrared Side Burner,
- Faux Granite Surfaces (White)
- All **304** Stainless Steel components,
- 8mm **304** Stainless Steel Cooking Grills,
- Warming Wrack **304** Stainless Steel,
- Main Cooking Surface excluding Warming rack 38" x 18",
- Arrives fully assembled
- 78,000 BTU Heat Output,
- Temperature Gauge
- Rotisserie Kit with Electric Motor (included),
- Bottle Opener
- Cast Iron Enameled Griddle plate (Not Included),
- Weather Cover (Not Included),
- Two Cooking Surface Halogen Lights,
- Control Knobs with Blue LED Lights,
- Electronic Ignition,
- Gliding Rubber Castor Wheels (2 with Brakes),
- Assembled Dimensions :
 - Grill unit 32x20x47",
 - Left Side Burner unit 25x20x35",
 - Right Side unit 25x20x35",
- Natural gas and Propane Ready.
- Propane Hose and Regulator included.
- Propane tank pull out for easy access
- Easy access grease trays for cleaning
- Large roller ball draws



MONT ALPI BUILT-IN 805 44" (MABI805)



Cut Out Dimensions

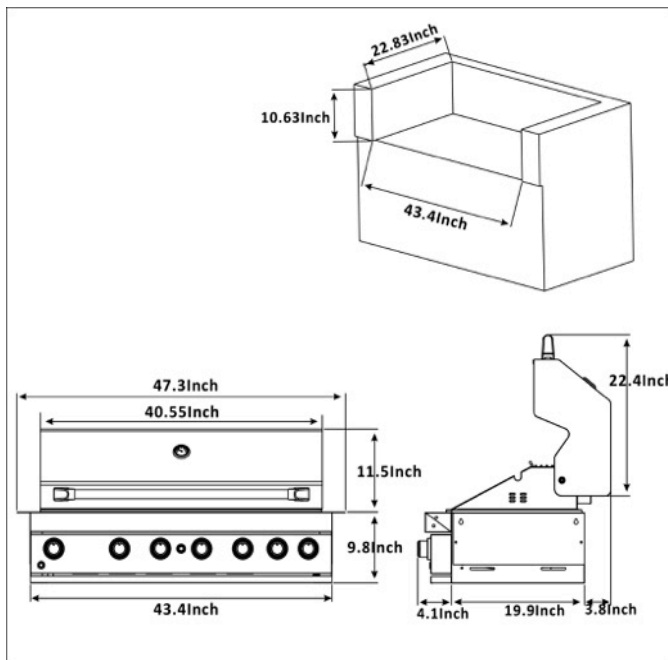

- DELIVERED FULLY ASSEMBLED
- Six main **304** Stainless Steel Burners.
- Ceramic Infrared Rear Burner.
- All Stainless Steel Cooking Components,
- 8mm **304** S/Steel Cooking Grills,
- Warming rack, **304** S/Steel
- Rotisserie Kit with Heavy Duty Electric Motor (included),
- Weather Cover (Not Included),
- Cast-iron Griddle Plate (Not included)
- Two Cooking Surface Halogen Lights,
- Control Knobs have Blue LED Lights,
- Electronic Ignition,
- 87.000 BTU Heat Output,
- Dimensions 43.5 x 23 x 25",
- Fully **304** Stainless steel ,
- Natural gas and Propane Ready.
- Propane Hose and Regulator included. (Natural Gas Hose not included)
- Temperature Gauge
- Bottle Opener



MONT ALPI BUILT-IN 400 32" (MABI400)



Cut Out Dimensions

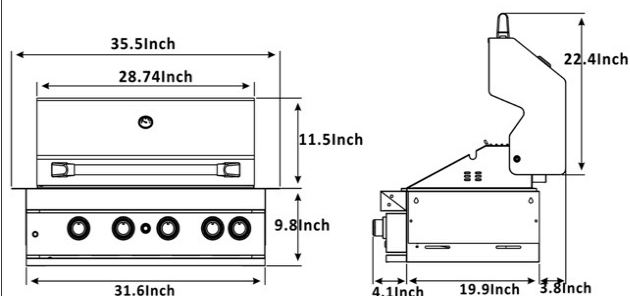
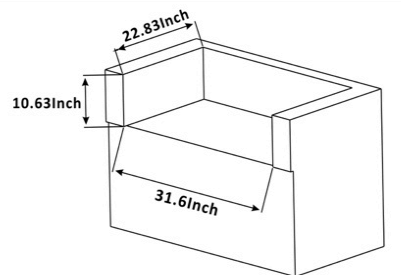

- DELIVERED FULLY ASSEMBLED
- Four main **304** Stainless Steel Burners.
- Ceramic Infrared Rear Burner.
- All Stainless Steel Cooking Components, 8mm **304** S/Steel Cooking Grills,
- Warming rack, **304** S/Steel
- Rotisserie Kit with Heavy Duty Electric Motor (included),
- Weather Cover (Not Included),
- Cast-iron Griddle Plate (Not included)
- Two Cooking Surface Halogen Lights,
- Control Knobs have Blue LED Lights,
- Electronic Ignition,
- 68.000 BTU Heat Output,
- Dimensions 32 x 23 x 25",
- Fully **304** Stainless steel ,
- Natural gas and Propane Ready.
- Propane Hose and Regulator included. (Natural Gas Hose not included)
- Temperature Gauge
- Bottle Opener



HEAT WAVE

DUAL LAYER INFRARED TECHNOLOGY

- NEW TECHNOLOGY
- Double Layer Flame Tamers
- All 304 Stainless Steel
- Retains Heat
- Reduces Flare Ups
- Even heat distribution
- Flavor Generator
- Creates smoke, smell and BBQ Enjoyment



Rotisserie Kit, Heavy Duty Electric Motor

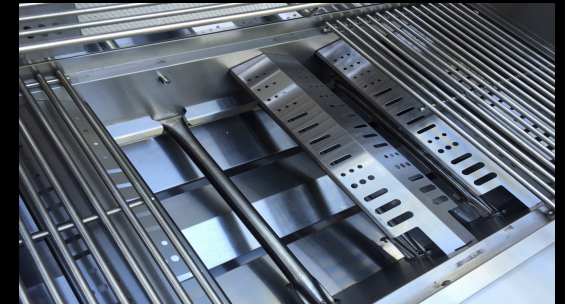

All 304 Stainless Steel Components

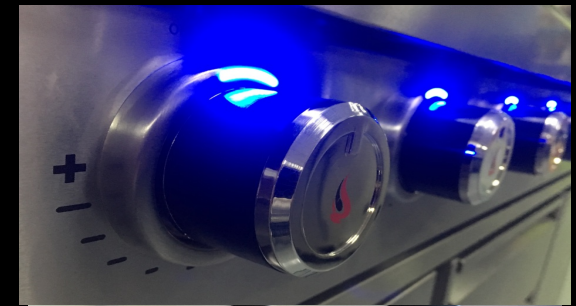

Blue LED Control Panel Lighting



Two Halogen Lights on the Cooking Surface



Mont Alpi
Peak Performance



Chef inspired. Crafted to perfection.



MONT ALPI 400 CART 32" (MAC400)



Mont Alpi

Peak Performance



MONT ALPI 300 CART 3 BURNER AVAILBLE

MONT ALPI 805 CART 6 BURNER AVAILBLE

- DELIVERED FULLY ASSEMBLED
- Four main **304** Stainless Steel Burners.
- Ceramic Infrared Rear Burner.
- All Stainless Steel Cooking Components,
- 8mm **304** S/Steel Cooking Grills,
- Warming rack, **304** S/Steel
- Rotisserie Kit with Heavy Duty Electric Motor (included),
- Weather Cover (Not Included),
- Cast-iron Griddle Plate (Not included)
- Two Cooking Surface Halogen Lights,
- Bottle Opener

- Control Knobs have Blue LED Lights,
- Electronic Ignition,
- 68.000 BTU Heat Output,
- Fully **304** Stainless steel ,
- Natural gas and Propane Ready.
- Propane Hose and Regulator included.
- Temperature Gauge

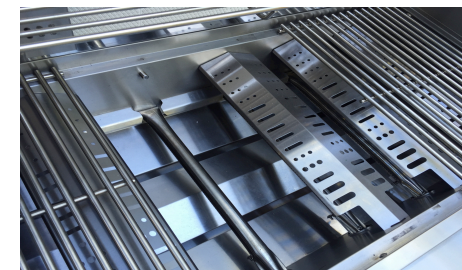
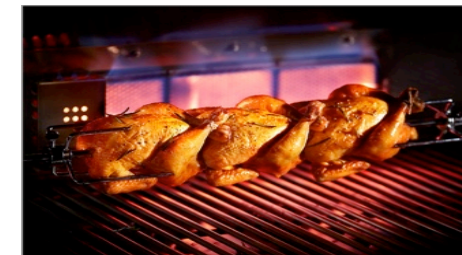

MONT ALPI PORTABLE PIZZA OVEN (MAPZ)



- DELIVERED FULLY ASSEMBLED
- Stainless Steel
- ”-U” shaped S/Steel burner
- 12,000 BTU
- Oven like performance in 5 Minutes (620 F)
- Perfect for Pizza
- 12" Pizza design
- Great for roasting (Whole chickens and larger meats)
- Removable front door
- Accurate temperature gauge
- Propane
- Removable Floor Pan
- Pull out fat tray

- Dishwasher friendly cleaning
- Stainless steel cooking grid
- 12" Chef style Pizza stone.
- Net weight 30 lb
- Easy start up ignition



A close-up photograph of a stainless steel grill lid. On the left, there is a circular temperature gauge with a red needle. In the bottom right corner, there is a black rectangular logo with a white flame icon and the text "Mont Alpi Peak Performance". The background shows a blurred outdoor setting with greenery and a hillside.

MONT ALPI WAS BORN OUT OF A GENUINE PASSION FOR THE GRILLING INDUSTRY. THERE IS A DEFINITE NEED FOR A GOOD ALL ROUND GRILL THAT CAN MAKE OUTDOOR LIFE FUN AND VERSATILE. AN AESTHETICALLY PLEASING RANGE TO SUIT ALL NEEDS.

A FAMILY BUSINESS WITH OVER 30 YEARS OF INDUSTRY EXPERIENCE AND PASSION. OUR GRILLS ARE ROBUST AND EXPERTLY MADE TO DELIVER THE ULTIMATE COOKING EXPERIENCE DEMANDED BY SEASONED BBQ GRILLERS.

YOU DON'T HAVE TO BE AN EXPERT TO USE MONT ALPI PRODUCTS, BUT ALL YOUR FRIENDS AND FAMILY WILL THINK YOU ARE WHEN THEY SEE AND TASTE WHAT YOU PRODUCE USING YOUR MONT ALPI GRILL. WE ARE HERE TO SUPPORT AND HELP YOU BECOME THE BEST CHEF IN THE NEIGHBORHOOD.

ENJOY YOUR GRILL !!!



Mont Alpi

Peak Performance

Authorized Dealer

25541 Arctic Ocean Dr, Lake Forest CA 92630.
Info@MontAlpiOnline.com Call- 949.207.9595

All Rights Reserved. 2017

www.MontAlpiOnline.com