

Burner Systems:

G31-18/20

G31-24/30

G31-33/39

For use with
natural gas only



DESIGN CERTIFIED
to
Manually Lighted, Natural Gas
Vented Decorative Appliance
ANSI Z21.84

**FOR INSTALLATION IN
SOLID-FUEL BURNING
FIREPLACES***

G31 TRIPLE BURNER VENTED GAS LOG SETS (MANUALLY LIGHTED)
WARNING

If the information in this manual is not followed exactly, a fire or explosion may result, causing property damage, personal injury, or loss of life.

Do not store or use gasoline or other flammable vapors and liquids in the vicinity of this or any other appliance.

WHAT TO DO IF YOU SMELL GAS:

- **Open a window.**
- **Do not try to light any appliance.**
- **Do not touch any electrical switch; do not use any phone in the building.**
- **Immediately call the gas supplier from a neighbor's phone. Follow gas supplier's instructions.**
- **If you cannot reach the gas supplier, call the fire department.**

Installation and service must be performed by a qualified professional installer, service agency, or the gas supplier.

This appliance is only for use with the type of gas indicated on the rating plate.

IMPORTANT: READ THESE INSTRUCTIONS CAREFULLY BEFORE STARTING INSTALLATION OF THE UNIT.

The Real Fyre gas log set is to be installed only in a solid-fuel burning fireplace with a working flue and constructed of noncombustible material. The installation, including provisions for combustion and ventilation air must conform with the *National Fuel Gas Code, ANSI Z223.1/NFPA 54*, or the *CSA B149.1, Natural Gas and Propane Installation Code*, and applicable local building codes.

A damper clamp is included to maintain the minimum permanent vent opening and to prevent full closure of the damper blade. **The chimney damper MUST be fully opened when burning the unit. The unit is designed to burn with yellow flames; thus adequate ventilation is absolutely necessary.**

To comply with certification, listings, and building code acceptances, and for safe operation and proper performance of this gas log set, use ONLY Peterson Real Fyre parts, decorative media, and accessories. Use of other controls, parts, and accessories that are not designed for use with Real Fyre gas log set is prohibited and will void all warranties, certifications, listings, and building code approvals, and may cause property damage, personal injury, or loss of life. Peterson will not be liable for any damages caused by this misuse.

***Note:** Solid-fuels shall not be burned in a fireplace where a decorative appliance is installed.



We recommend that our gas hearth products be installed and serviced by professionals who are certified in the U.S. by the National Fireplace Institute® (NFI) as NFI Gas Specialists.

INSTALLER:
Leave this manual with the appliance.
CONSUMER:
Retain this manual for future reference.



TABLE OF CONTENTS

GETTING STARTED

IMPORTANT PRE-INSTALLATION AND FIREPLACE SAFETY INFORMATION	3
FIREPLACE OPERATING SAFETY INFORMATION	4
SPECIFICATIONS	5
DAMPER CLAMP INSTRUCTIONS	6
G31 BURNER REPLACEMENT PARTS LIST	7

INSTALLATION

INSTALLATION	8
<i>INSTALL BURNER</i>	8
<i>LAVA GRANULES/COALS (DECORATIVE)</i>	9
<i>LOG LOCATORS (if applicable)</i>	9
<i>LOG SET, GLOWING EMBERS, AND BRYTE COALS PLACEMENT</i>	10
NOTES PAGE	14

USE, CARE, & SERVICE

LIGHTING INSTRUCTIONS	15
<i>FOR YOUR SAFETY, READ BEFORE LIGHTING</i>	15
<i>TO SHUT OFF GAS TO THE APPLIANCE</i>	15
CLEANING AND SERVICING	16
FLAME DESCRIPTION	16
NOTES PAGE	17
TROUBLESHOOTING	18
WARRANTY	20

IMPORTANT PRE-INSTALLATION AND FIREPLACE SAFETY INFORMATION

CAUTION: Installation and repair must be done by an NFI Certified or other qualified professional installer.

Installer: Carefully read these instructions before installing this gas burner system. Be sure you understand all safety precautions and warnings contained in this manual.

- A. **BE CAREFUL:** If not installed, serviced, and used correctly per these instructions, this product can cause serious personal injury, property damage, or loss of life.
- B. **WARNING:** When installing in a solid-fuel-burning fireplace, the chimney flue, damper, and firebox must be thoroughly CLEANED of soot, creosote, ashes, and loose paint, and must be inspected by a qualified chimney cleaner. Some older fireplaces may need repair prior to installing this appliance.
- C. The fireplace floor must be level and smooth.
- D. This appliance is only for use with the type of gas indicated on the rating plate. This appliance is **NOT FIELD CONVERTIBLE** for use with other gasses.
CHECK GAS TYPE (natural): The gas supply must be the same as stated on your burner system rating plate. If gas supply is different, **DO NOT INSTALL**. Contact your dealer for immediate assistance.
- E. **INSUFFICIENT GAS PRESSURE WILL KEEP THE UNIT FROM OPERATING PROPERLY. DO NOT USE IF GAS PRESSURE IS LOWER THAN THE MINIMUM REQUIREMENT.**
- F. The *minimum* inlet gas supply pressure for purposes of input adjustment is **7"** water column (w.c.) on **natural gas**. Insufficient gas pressure will affect proper operation of the unit. Do not install this gas appliance if minimum pressure is not available. The *maximum* inlet gas supply pressure is **10.5"** w.c. on natural gas.
- G. **The gas piping system must be sized to provide minimum inlet pressure at the maximum flow rate (BTU/hr).** Undue pressure loss will occur if the pipe is too small, or the run is too long. Gas supply pipe must be 1/2" minimum interior diameter. If the gas line is longer than 20', a larger diameter line may be necessary. Refer to the NFPA 54 guidelines for further details.
- H. Input ratings shown in BTU per hour are for elevations up to 2,000 ft. For elevations above 2,000 ft., refer to the National Fuel Gas Code or contact manufacturer before installing this product.
- I. This gas appliance and its main gas valve must be disconnected from the gas-supply piping system during any pressure testing of that system at test pressures in excess of 1/2 psig.
- J. This gas appliance must be isolated from the gas-supply piping system by closing the equipment shutoff valve connected to the gas-supply line during any pressure testing of the gas-supply piping system at test pressures equal to or less than 1/2 psig.
- K. **To install the gas appliance in your fireplace, the fireplace MUST meet the minimum size requirements (see product specifications table in SPECIFICATIONS section).**
- L. This appliance may be installed in an aftermarket, permanently located, manufactured (mobile) home, where not prohibited by local codes. Installation of appliances designed for manufactured home (U.S. only) or mobile home installation must conform with the Standard CAN/CSA Z240 MH, Mobile Housing, in Canada, or with the Manufactured Home Construction and Safety Standard, Title 24 CFR, Part 3280, in the United States, or when such a standard is not applicable, ANSI/NCSBCS A225.1/NFPA 501A, Manufactured Home Installations Standard.
- M. **DO NOT install this burner system in a fireplace with an ash lip or recess greater than 3/4".**
- N. If this burner system is installed in a fireplace with **glass doors**, and the doors have a frame that obstructs airflow to the fireplace floor, the frame **MUST** have slots (above the fireplace floor) that allow adequate ventilation. The opening (with doors fully open) **MUST** meet the minimum fireplace size front width and height requirements. The glass doors **MUST** be fully open when the burner is in operation. See the SPECIFICATIONS section for details.

FIREPLACE OPERATING SAFETY INFORMATION

- A. Adults **MUST** be present when this gas appliance is operating. This appliance **MUST NOT** be left burning when unattended or while anyone is sleeping.
- B. Keep the area of the gas burner system clear and free from combustible materials, gasoline, and other flammable vapors and liquids.
- C. DO NOT use this appliance if any part has been underwater. Immediately call a qualified service technician to inspect the appliance and to replace any part of the control system and any gas control that has been underwater. Attempted operation may result in fire or explosion resulting in property damage, personal injury or loss of life.
- D. **A fireplace screen must be in place when the system is burning.** Provisions for adequate combustion air must be maintained. Unless other provisions for combustion air are provided, the screen shall have an opening(s) for introduction of combustion air. Combustion air is adequate when all flames curl into the fireplace and away from the screen. **When a glass fireplace enclosure (door) is used, the glass doors MUST be fully open when the burner is in operation.**
- E. Do not remove the rating plates or the warning tags. These are an integral safety and identification component of this appliance.
- F. Be sure to read the CLEANING AND SERVICING and FLAME DESCRIPTION sections.

SPECIFICATIONS

Real Fyre gas burner systems must be installed only in a wood burning fireplace with the minimum firebox dimensions and venting requirements met (see table on this page). This appliance is designed to burn with yellow flames; adequate ventilation is absolutely necessary.

Product Specifications

Model	Dimensions				BTU Rating
	Width *		Depth ‡	Height	Nat. Gas
	Front	Rear †			
G31-18/20 (18" log set)	23"	14"	16"	17"	55k
G31-24/30 (24" log set)	29"	17"	16"	17"	65k
G31-24/30 (30" log set)	32"	17"	16"	17"	65k
G31-33/39 (33" log set)	34"	23"	16"	17"	85k
G31-33/39 (39" log set)	41"	23"	16"	17"	85k
Important Information Regarding Dimensions					
* These required widths allow for centering of the unit.					
† Rear width is at corresponding depth.					
‡ If an ash lip exists, the depth requirement begins inside of the lip (see Fig. 5-1 below)					

Table 1 - Product Specifications

Fireplace Requirements

These requirements MUST be met:

Ash Lip/Recess

DO NOT install this burner system in a fireplace with an ash lip or recess greater than $\frac{3}{4}$ ". See Fig. 5-1.

Glass Doors

If this burner system is installed in a fireplace with glass doors, and the doors have a frame that obstructs airflow to the fireplace floor, the frame MUST have slots (above the fireplace floor) that allow adequate ventilation. See Fig. 5-2.

Important: The opening (with doors fully open) MUST meet the minimum fireplace size front width and height requirements. See Table 1 and Fig. 5-2.

Important: The glass doors MUST be fully open when the burner is in operation.

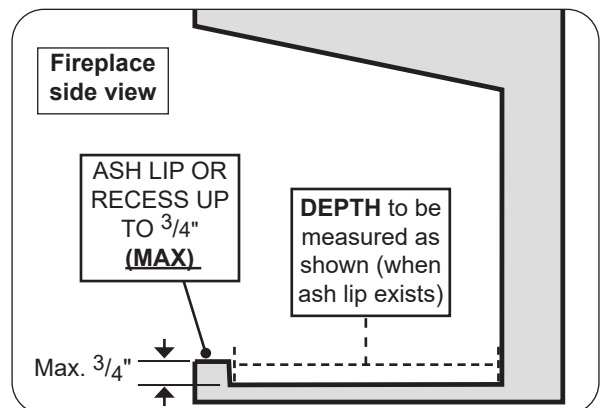

Fig. 5-1 Ash lip/recess detail

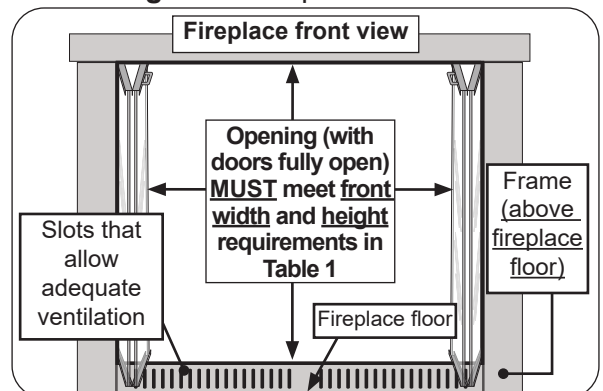

Fig. 5-2 Glass doors frame ventilation (if applicable)

DAMPER CLAMP INSTRUCTIONS

The damper clamp with hex bolt (Fig. 6-1) is provided as a means to prevent full closure of the damper blade. The clamp is easily attached to most damper blades with pliers or a wrench, and must be permanently installed. The clamp is designed to prevent accidental closure of the damper when installed as illustrated (Fig. 6-2). Should the clamp not fit, or fail to provide the permanent vent opening listed in Table 2 below, have a permanent stop installed, remove the damper blade, or have the damper cut to provide the minimum permanent opening required.

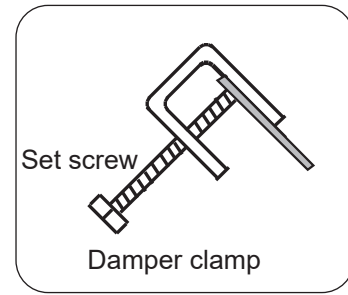

Fig. 6-1 Damper clamp detail

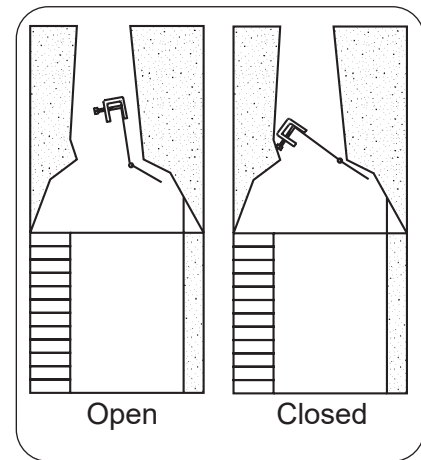

Fig. 6-2 Damper open / closed

Venting Requirements

Minimum permanent free opening area of chimney damper for venting (sq. in.)			
For factory-built fireplaces			
Chimney height	18/20"	24/30"	33/39"
15'	24	30	42
20'	20	25	35
30'	16	19	27
For masonry-built fireplaces			
15'	35	41	52
20'	32	37	47
30'	29	34	43

Table 2 - Minimum Chimney Damper Venting Requirements

Note: The minimum chimney height from hearth to top of chimney is 15'.

THESE ARE MINIMUM DAMPER OPENING SPECIFICATIONS.

THE DAMPER MUST BE COMPLETELY OPENED WHEN OPERATING THIS GAS APPLIANCE TO ACHIEVE THE BEST VENTILATION POSSIBLE.

G31 BURNER REPLACEMENT PARTS LIST

Note: Photos not to scale

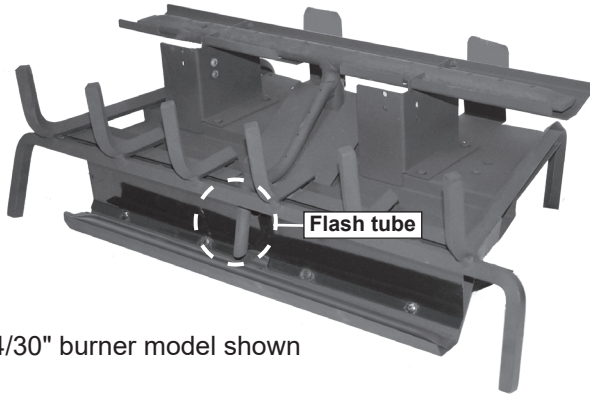

24/30" burner model shown

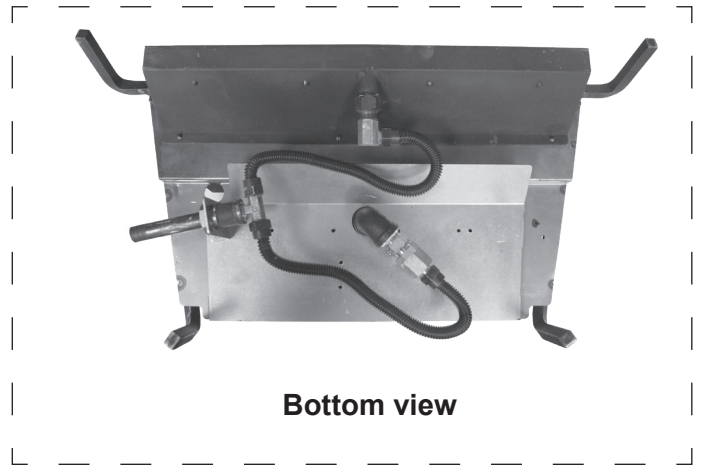

Bottom view



7

3

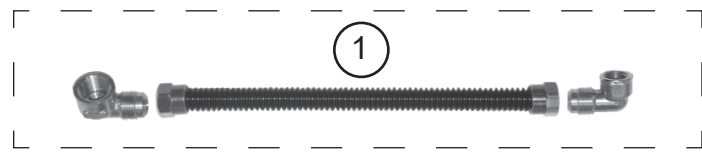

1

4



2

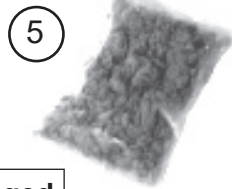

5



6

The log set is purchased and packaged separately; contact your local Real Fyre dealer when ordering. Refer to the supplemental instruction also included with your burner system, or the instructions included with the log set.

Replacement parts can be ordered from your local Real Fyre dealer.

Item	Description	18/20" model		24/30" model		33/39" model	
		Part No.	Qty.	Part No.	Qty.	Part No.	Qty.
1.	Flex connector (w/ adapters), 1/2" O.D. x 24"	CK-5-24SP	1	CK-5-24SP	1	CK-5-24SP	1
2.	Damper clamp	DC-1	1	DC-1	1	DC-1	1
3.	Lava fyre coals	LFC-6	1	LFC-6	1	LFC-6	1
4.	Lava granules	LF-5	1	LF-5	1	LF-5	1
5.	Glowing embers	EM-15	1	EM-15	2	EM-15	2
6.	Bryte coals	EM-11	1	EM-11	1	EM-11	2
7.	Log locator w/ screw and nut (33/39 model only)	-	-	-	-	UP-17	2

INSTALLATION

The Real Fyre burner system must be installed by a qualified professional service technician. Instructions must be followed carefully to ensure proper performance and full benefit from the burner system. **Check to be sure the burner system is designed and labeled for the type of gas (natural gas only) supplied to the fireplace.** Fireplace floor must be level, clean, and smooth (see FIREPLACE SAFETY INFORMATION section).

WARNING: Failure to position the parts in accordance with these diagrams or failure to use only parts specifically approved with this appliance may result in property damage or personal injury.

REFER TO THE BURNER PARTS LIST WHEN FOLLOWING THESE INSTRUCTIONS.

24" burner model shown here.

INSTALL BURNER

1. MAKE SURE THE FIREPLACE GAS SUPPLY IS TURNED OFF.
2. Locate the gas-supply stub inside the fireplace and remove the cap, if attached (reference Fig. 8-2).

CAUTION: When removing the cap, make sure the stub does not turn, loosening the connection inside the wall.

3. Remove the small adapter connected to the flex connector (included). Attach the adapter to the nipple found on the bottom of the burner pan using a pipe compound resistant to all gasses. Tighten securely. Then attach the flex connector to the adapter. Tighten securely (See Fig. 8-1).

4. Place the burner system in the fireplace. Center the burner from left to right in the fireplace. (Reference Fig. 8-2 for orientation.)

Note: Ensure the porcelainized panel is clean of all dust. Use a clean soft cloth if necessary. See Fig. 8-4.

5. **Be sure gas to the fireplace is off.** Remove the large adapter connected to the flex connector. Attach the adapter to the gas-supply stub using a pipe compound resistant to all gasses. Tighten securely. Then attach the flex connector to the adapter. Tighten securely (See Fig. 8-2).

6. **LEAKTEST:** Use a long-necked butane lighter, or lay a lighted match next to the burner pipe, and carefully turn on the gas supply until the burner ignites. Test at all connections for leaks using the appropriate soapy water solution. If bubbles appear, a leak is present. Turn off the gas and tighten at all connections. Repeat until no leaks are present. If a leak persists, turn off the gas supply and contact the local gas company or dealer. **NEVER USE A FLAME TO CHECK FOR LEAKS.**

Turn off the gas supply prior to proceeding.

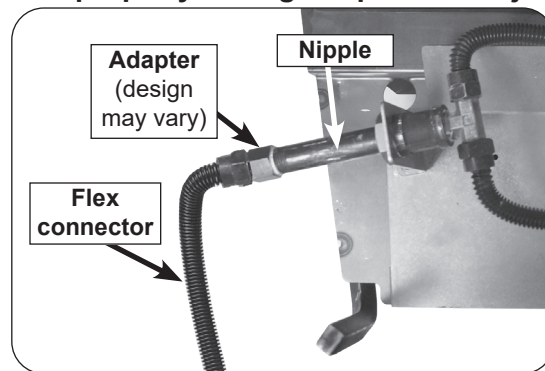

Fig. 8-1 Connect flex to burner

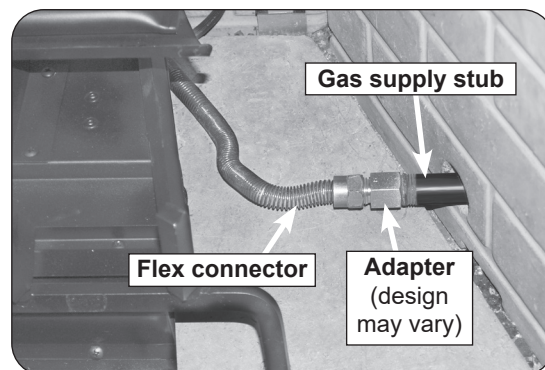

Fig. 8-2 Connect flex to gas supply

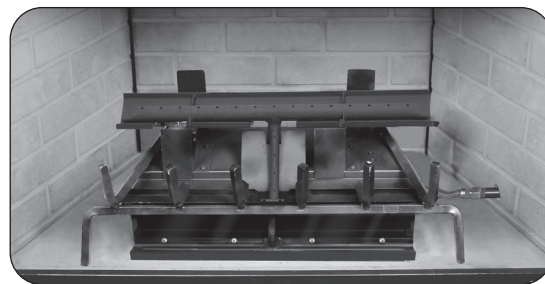

Fig. 8-3 Orientation

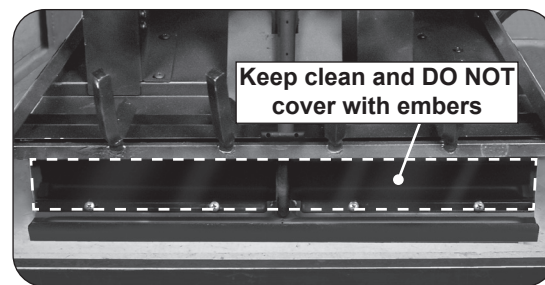

Fig. 8-4 Ensure a clean panel

LAVA GRANULES/COALS (DECORATIVE)

1. Spread the supplied lava granules on the floor of the fireplace, around the front and sides of the burner system (see Fig. 9-1).
2. Repeat this process for the supplied lava coals (on top of the already placed lava granules).

Note: DO NOT place any lava media on the burner system, or behind it.

LOG LOCATORS (if applicable)

33/39 models include a set of log locators. They are used to support the front logs of select log sets. If the log set chosen includes log locator install details (in placement instructions), install accordingly. If not, discard the log supports.

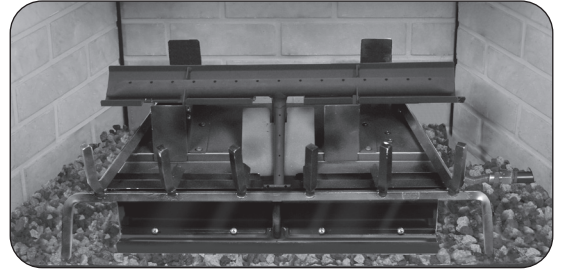

Fig. 9-1 Place lava media

INSTALLATION (cont.)

LOG SET, GLOWING EMBERS, AND BRYTE COALS PLACEMENT

- Read all safety warnings and important information in this manual and the instructions supplied with the log set - or supplemental instructions supplied with burner system - to ensure proper placement.
- **DO NOT** add any additional embers to this setup. Any additional embers will cause unsafe operation. ONLY use the embers supplied with your burner system. If any embers are included with your log set, **DISCARD** them as they are not applicable.
- Your log set design may slightly vary from the images shown here, but initial placement is the same.
- Refer to the section appropriate for you log set chosen (below or page 12).

IMPORTANT

THIS SECTION BELOW ADDRESSES SPECIFIC PLACEMENT FOR CHB, CHD, CHAO, CHMBW, CHS, CHNA, AND CHNS LOG SETS ONLY.

FOR MCO AND MCS LOG SETS, SKIP THIS SECTION AND GO TO PAGE 12 FOR PLACEMENT.

Generic Placement Steps - CHB, CHD, CHAO, CHS, CHNA, CHNS

Important: **DO NOT** place any embers on top of the flash tube to ensure proper operation.

All models listed above begin with the bottom log and ember placement shown below. To complete log placement continue to the supplemental instruction supplied with your burner system, and locate your specific log set.

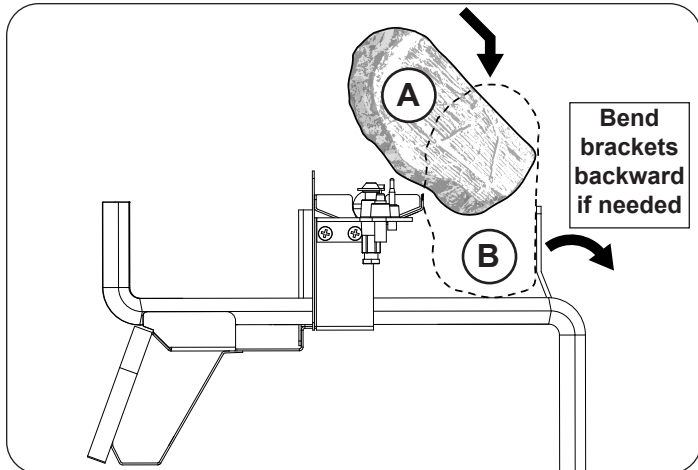

Rear log placement detail: First place the log, at an angle, against the rear burner brackets (see A). Then slide the log down into position – flat on the burner (see B).

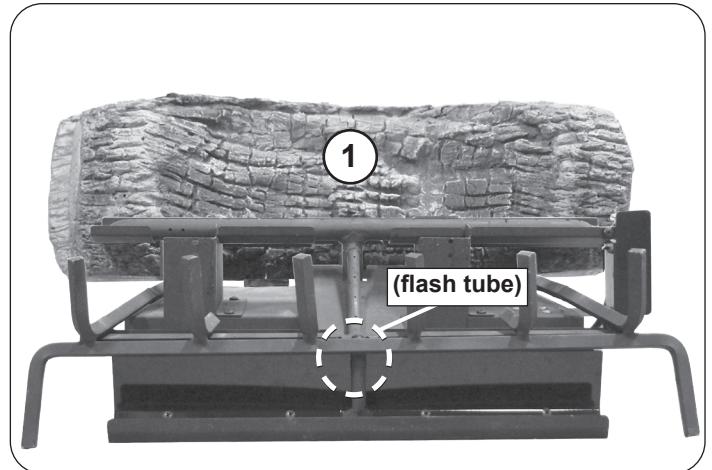

Once placed, the rear log (log #1) should appear as shown. The log should rest flat between the rear brackets and top burner.

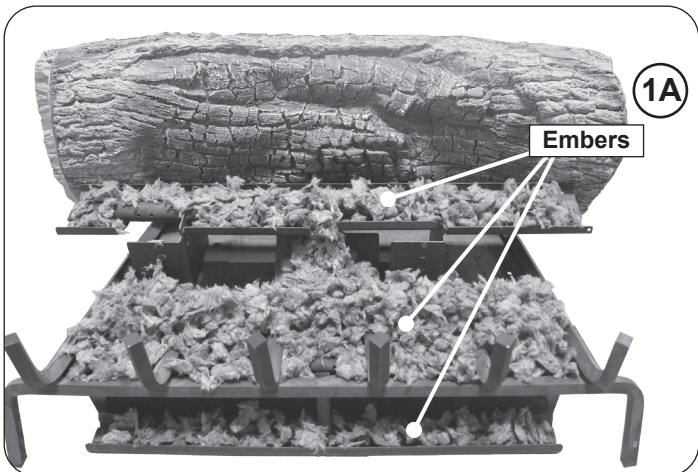

Place the glowing embers (supplied with burner) heavily and evenly in the areas shown. **Break up any clumps that may have developed during shipment.** Store any excess embers if applicable.

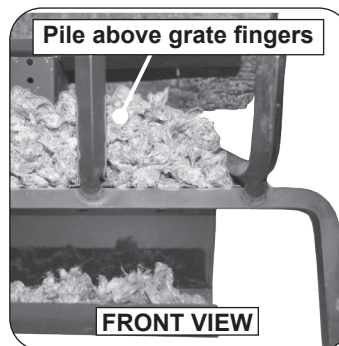

Ember placement detail - place heavily as shown.

INSTALLATION (cont.)

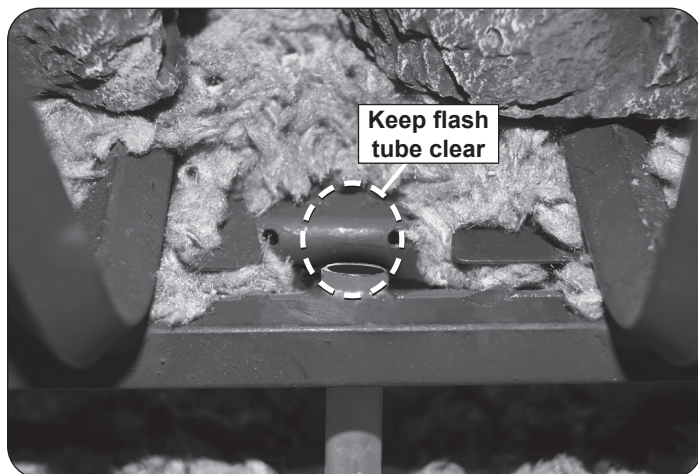

DO NOT place any embers on top of the flash tube to ensure proper operation. **Keep the area shown above clear at all times.**

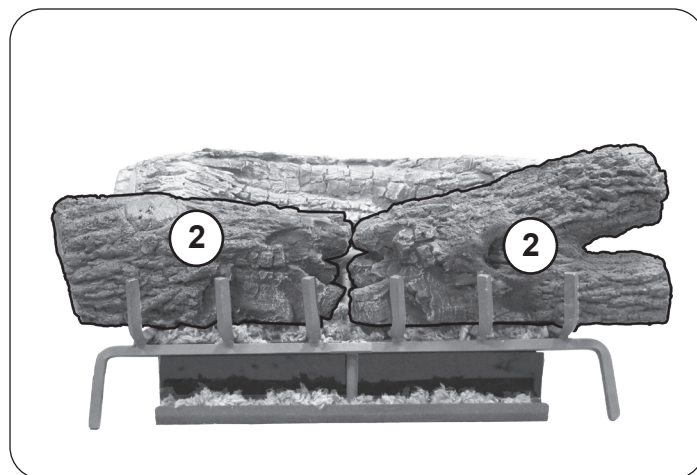

Place the left and right front log pieces (log #2) as shown. Rest the logs with their backs against the burner assembly behind them. **DO NOT** place the logs forward or on top of the grate fingers.

The logs should compress the embers below and create a seal.

Note: For 36" log sets, log locators (included with burner) must be installed. Refer to the appropriate section in the supplemental instructions specific to your 36" log set.

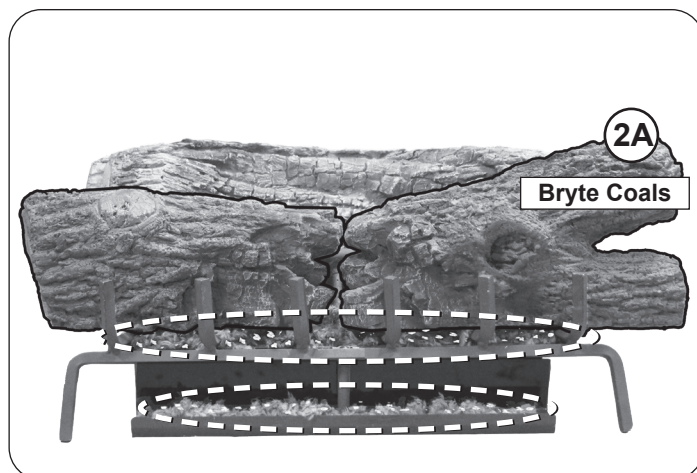
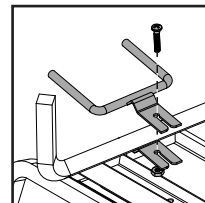

Separate half of the supplied bryte coals into small pieces, and evenly place them over the glowing embers in the middle ember bed as shown. Repeat this process for the remaining (second half) of bryte coals over the bottom ember bed.

FOLLOW THE SUPPLEMENTAL INSTRUCTIONS SUPPLIED WITH YOUR BURNER SYSTEM TO COMPLETE LOG PLACEMENT (LOCATE YOUR SPECIFIC SET).

Important: Adequate ventilation is absolutely necessary! Adequate spacing between the logs is **NECESSARY** and **MUST** be maintained. Provided significant, noticeable sooting does not occur, some flexibility is possible in top log placement to suit your individual preference. If you experience a continued accumulation of black carbon (soot) on your logs it is an indication of incomplete combustion and you should move the effected log(s) so as to minimize the flame contact on the effected log(s). If significant sooting continues, stop using this gas log set. Read the supplemental instructions supplied with your burner system completely and carefully.

CAUTION: **BURN HAZARD!** Logs will remain hot for some time after use. If you need to reposition any log to maintain the proper layout, use heat-resistant gloves or allow logs adequate time to cool before handling.

INSTALLATION (cont.)

IMPORTANT

THIS SECTION BELOW ADDRESSES SPECIFIC PLACEMENT FOR MCO AND MCS LOG SETS ONLY. FOR ALL OTHER LOG SETS, GO BACK TO PAGE 10 FOR PLACEMENT.

Generic Placement Steps - MCO, MCS

Important: DO NOT place any embers on top of the flash tube to ensure proper operation.

All models listed above begin with the bottom log and ember placement shown below. To complete log placement continue to the instruction supplied with your log set.

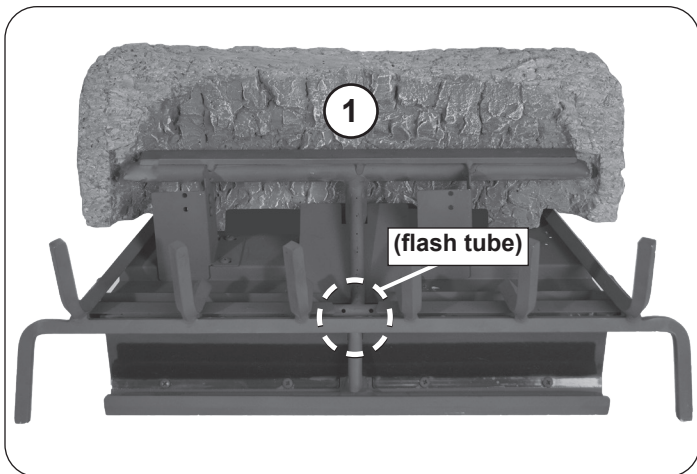

Place the rear log (log #1) as shown. The log should rest flat between the rear brackets and top burner.

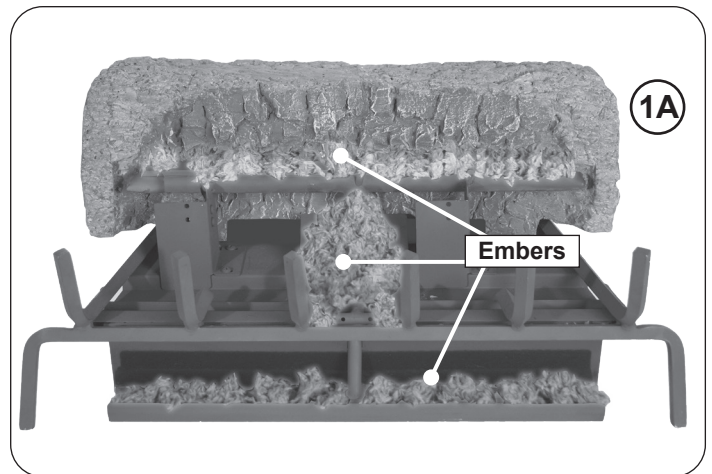

Place the glowing embers (supplied with burner) evenly in the areas shown. **Break up any clumps that may have developed during shipment.** Keep some embers for future placement along the front log.

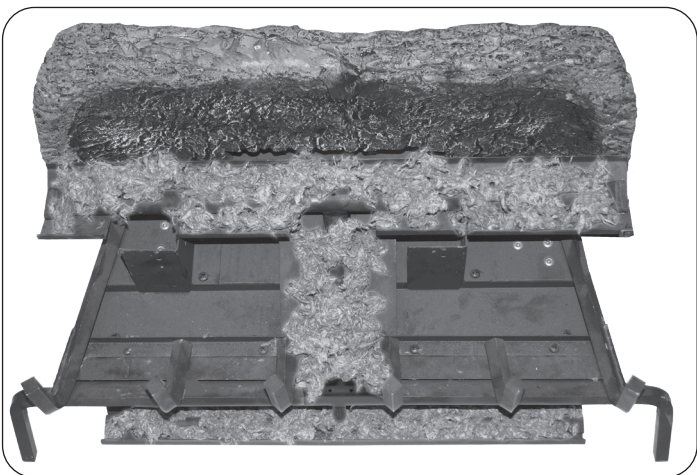

Ember placement detail.

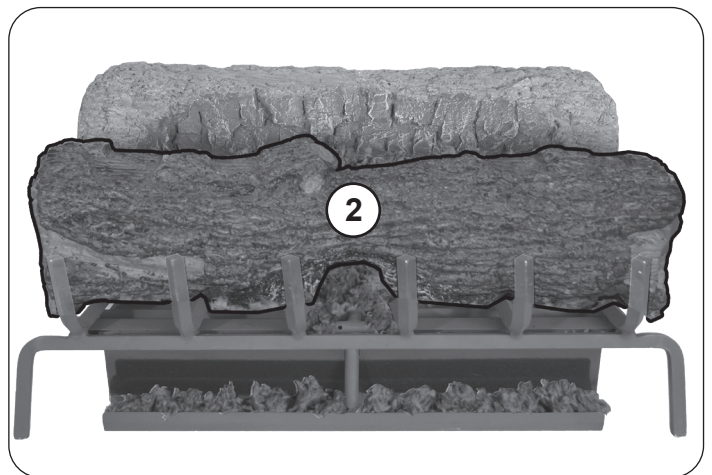

Place the front log (log #2) as shown. Rest the log with its back against the burner assembly behind it. **DO NOT place it forward or on top of the grate fingers.**

INSTALLATION (cont.)

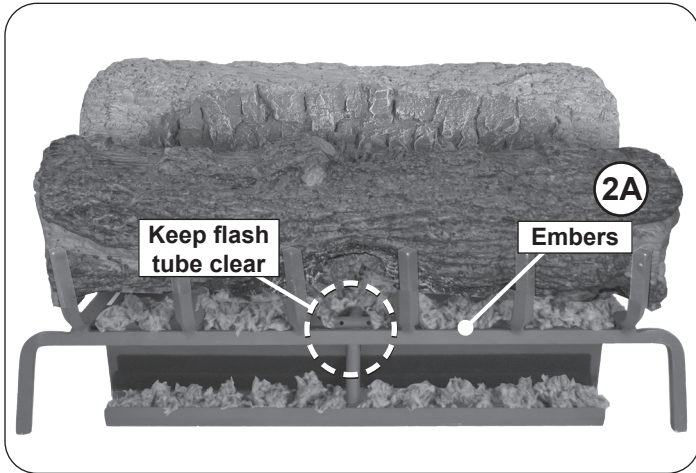

Place the remaining glowing embers evenly in the area along the front log as shown.

Store any excess embers.

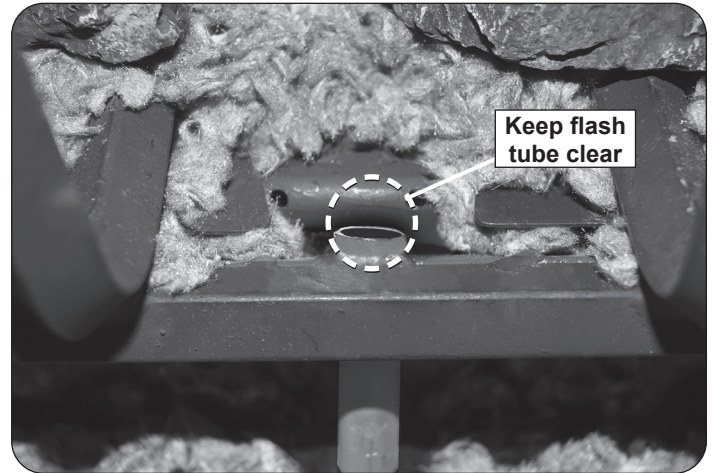

DO NOT place any embers on top of the flash tube to ensure proper operation. **Keep the area shown above clear at all times.**

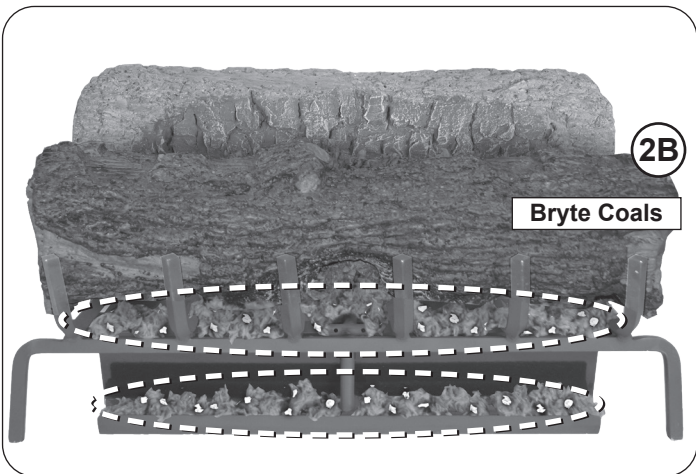

Separate half of the supplied bryte coals into small pieces, and evenly place them over the glowing embers in the middle ember bed as shown. Repeat this process for the remaining (second half) of bryte coals over the bottom ember bed.

FOLLOW THE INSTRUCTIONS INCLUDED WITH YOUR SPECIFIC LOG SET TO COMPLETE LOG PLACEMENT.

Important: Adequate ventilation is absolutely necessary! Adequate spacing between the logs is **NECESSARY** and **MUST** be maintained. If you experience an accumulation of black carbon (soot) on your logs it is an indication of incomplete combustion and you must correct the log placement. If significant sooting continues, stop using this gas log set. Read the instructions supplied with the log set completely and carefully.

CAUTION: **BURN HAZARD!** Logs will remain hot for some time after use. If you need to reposition any log to maintain the proper layout, use heat-resistant gloves or allow logs adequate time to cool before handling.

Please use this page to record any information that you may want to have at hand.

LIGHTING INSTRUCTIONS

FOR YOUR SAFETY, READ BEFORE LIGHTING

WARNING: IF YOU DO NOT FOLLOW THESE INSTRUCTIONS EXACTLY, A FIRE OR EXPLOSION MAY RESULT, CAUSING PROPERTY DAMAGE, PERSONAL INJURY, OR LOSS OF LIFE.

- A. BEFORE LIGHTING**, smell all around the unit area for gas. Be sure to smell next to the floor, because some gas is heavier than air and will settle on the floor.
- B. WHAT TO DO IF YOU SMELL GAS**
 1. Shut off the gas to the appliance.
 2. Extinguish any open flame.
 3. If odor continues, immediately call your gas supplier or the fire department.
- C.** Use only a proper key to turn the gas line valve. Never use tools. If the valve will not turn, **DO NOT** try to repair it. Call a qualified professional service technician. Force or attempted repair may result in fire or explosion.

1. **STOP!** Read the safety information above.
2. Ensure the key valve is completely in the **OFF** position before beginning lighting sequence.
3. Light a long-stem match or a long-necked butane lighter, and place the flame against the center of the top burner (Fig. 15-1).
4. **Once the flame is in position**, slowly turn the key valve counter-clockwise toward the **ON** position until it no longer rotates (see Fig. 15-2). Your burner should light.

WARNING: If the burner does not light within (5) seconds of turning on the key valve, immediately turn the key valve clockwise toward the **OFF** position until it no longer rotates.

Wait approximately five (5) minutes to clear out any gas, and repeat steps 3-4 above.

If your burner fails to light again, turn the key valve clockwise toward the OFF position until it no longer rotates and contact your dealer or gas supplier.

Note: The flame height can be adjusted via the key valve.

TO SHUT OFF GAS TO THE APPLIANCE

To extinguish your gas burner, turn the key valve clockwise toward the **OFF** position until it no longer rotates (see Fig. 15-2). Be sure the key valve is turned fully off to avoid any gas leakage.

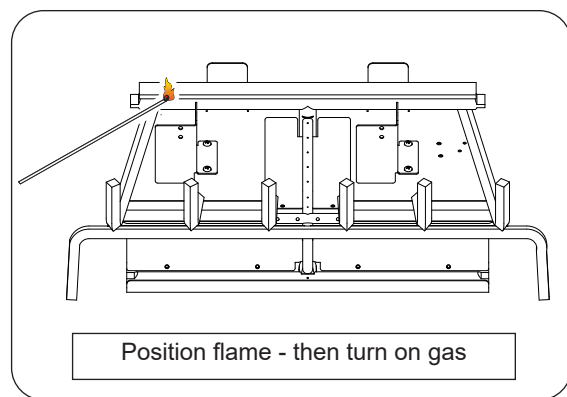

Fig. 15-1

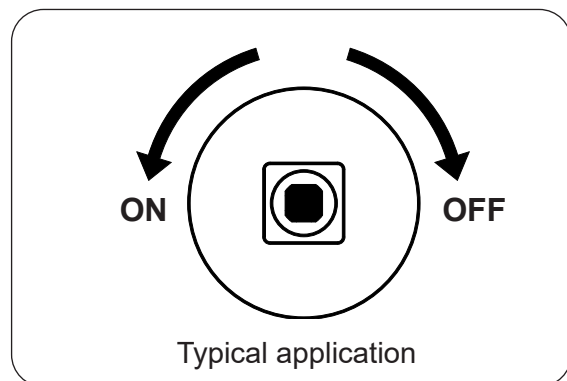

Fig. 15-2

CLEANING AND SERVICING

Note: Discoloration is common on the grate after burning.

Note: Servicing may be necessary to ensure proper operation and burn characteristics.

Always shut off the gas to the appliance while performing service work.

Allow the appliance to cool before servicing.

Installation, service, and repair must be done by an NFI Certified or other qualified professional service technician. The appliance should be examined before use, and must be inspected at least annually to prevent burner shutdown, sooting, odors, etc. It must be checked for clean burning operation with the correct tools to service this unit. More frequent servicing may be required. It is imperative that all components and compartments, burner(s), and circulating air passageways of the appliance be kept clean and free of all obstructions (as applicable).

In addition, a periodic examination and cleaning of the fireplace venting system should be conducted by a qualified professional service technician.

Any safety screen or guard removed for servicing must be replaced prior to operating this appliance.

Verify proper operation after servicing.

If, after a period of use, the flames start to exhibit unusual shapes and behavior, or the burners fail to ignite smoothly, the burner may require cleaning or servicing. If this happens, it is recommended to contact the nearest dealer to get the appliance serviced.

DO NOT remove the rating plates or the warning tags. These are an integral safety and identification component of this appliance.

We recommend following these instructions at the beginning of each fireplace season and as needed throughout the year, depending on your usage pattern and the environmental conditions in your home.

FLAME DESCRIPTION

Observe the flames. The top and middle burner flames should be blue at the base and a combination of blue/yellow at the body and at the tips. The top flames should be approximately 3-5" above the logs, with the center flame being the tallest. The middle flames should be approximately at or below the top of the front log. The ember flames should be 1/4" to 1" above the embers. (See 16-1 for example.)



Fig. 16-1 Flame appearance

Please use this page to record any information that you may want to have at hand.

TROUBLESHOOTING

POSSIBLE CAUSE	SOLUTIONS
1 BURNER SHUTTING DOWN DURING OPERATION	
A. Insufficient or excessive gas pressure	A1. Check gas pressure (Read D.- F. of IMPORTANT PRE-INSTALLATION AND FIREPLACE SAFETY INFORMATION section, & check with local gas company). A2. Other gas appliances may be on the same gas line, dropping gas pressure to the burner. Check pressures with everything operating to ensure adequate pressure.
B. Fireplace too small for unit	B. Ensure minimum requirements are met (see SPECIFICATIONS section).
C. Blockages on burner	C. Vacuum any lava granules or material that may have fallen onto burner port area.
2 LOW FLAME HEIGHT	
A. Gas pressure	A. Check gas pressure (see Section 1, A1 of this table).
B. Key valve not fully open	B. Open key valve fully.
C. Blockage or kink in flex connector kit, plumbing, or burner orifice	C. Clean out blockage. If flex connector is kinked, replace it.
3 BURNER NOT BURNING EVENLY	
A. Burner ports clogged	A. Clean burner ports.
B. Top burner lights; bottom burner has delayed ignition.	B. Check gas pressure. Can be caused by too small of a gas line (see Section 1, A1 of this table).
4 ODORS	
A. Gas leak	A. Shut off gas, if possible. Follow instructions on front page. Have a qualified professional installer or the gas company correct all leaks.
B. New home, new carpet, or new paint	B. When these odors are drawn into the fireplace, this may cause objectionable odors. Thoroughly ventilate the area before restarting your burner system.
C. Damper closed	C. Ensure that damper is open.

5**SMOKING AND/OR SOOTING**

A. Poor draft or downdraft	A. Check for chimney blockage. Be sure chimney is at least 3' taller than anything within 10' of it in all directions. If not, consult a chimney sweep. A chimney cap or fan may help.
B. Damper closed	B. Ensure that damper is open.
C. Burner is positioned too close to the front of the firebox	C. Move burner system to the center of the firebox.
D. Improper media placement	D. See INSTALLATION section for proper media placement.
E. Air shutters blocked (if applicable)	E. Air shutters are blocked with debris. Vacuum debris away from air shutter.
F. Log placement	F. See solution in Section 1, B.
G. Using natural-gas burner on propane gas	G. If the gas listed on the nameplate does not match the gas you are burning, shut down the burner system immediately. Then call your dealer.
H. Adding any accessories to burner system	H. Shut down burner system and take off any accessories that do not belong with the system.

WARRANTY

PETERSON VENTED DECORATIVE GAS APPLIANCE LIMITED WARRANTY

Robert H. Peterson Co. ("RHP") warrants your Real Fyre vented decorative gas appliance to be free from defects in material and workmanship. Peterson vented refractory gas logs are warranted for **as long as the original purchaser owns them (lifetime) when used indoors and for THREE (3) YEARS when used outdoors.**

Peterson vented fiber-ceramic blended gas logs are warranted for **FIVE (5) YEARS when used indoors and for THREE (3) YEARS when used outdoors.**

Peterson **indoor** vented gas log burners and stainless steel burners (excluding controls) are warranted for **TEN (10) YEARS.**

Peterson **outdoor** vented stainless steel burners (excluding controls) are warranted for **FIVE (5) YEARS.**

The **SPK-26** is warranted for **THREE (3) YEARS** and **APK-17** (including -17 valve) is warranted for **TWO (2) YEARS.**

All other valves, pilots, and controls are warranted for **ONE (1) YEAR** (excluding batteries).

Peterson glass, gems, and nuggets are warranted for **TEN (10) YEARS.**

A COPY OF YOUR SALES SLIP FOR PROOF OF PURCHASE IS REQUIRED

This warranty applies to the original purchaser for products which are installed in the United States or Canada and which are operated and maintained as intended for single family residential usage. This warranty is valid only with proof of purchase, commences on the date of purchase, and terminates (both as to original and any replacement products) on the anniversary date of the original purchase of the product per the above schedules.

This warranty covers defects in material and workmanship. This warranty **does not** cover parts which become defective as a result of negligence, misuse, use not in compliance with the Installation and Owner's Manual, accidental damage, improper handling, improper storage, improper installation, **lack of required routine maintenance** (as specified in the Installation and Owner's Manual), electrical damage, local gas impurities or failure to protect against combustible materials. Product must be installed (and gas must be connected) as specified in the Installation and Owner's Manual by a **qualified professional installer**. This warranty **does not** apply to rust, corrosion, oxidation, or discoloration unless the affected part becomes inoperable. Peterson products including valves, pilots and controls, are designed and certified to be used as a system. Modifications to products which are not specifically authorized will void this warranty and could render the product to be unsafe. Burners, valves, parts, accessories, remotes, etc. used with this product must be Peterson products or this warranty is void.

Warranted items will be repaired or replaced at Peterson's sole discretion. This warranty **does not** cover labor or labor related charges, except as provided by separate specific written programs from the Peterson Co. All repair work must be performed by a qualified professional service person and requires prior approval of Peterson.

Peterson may require the defective product or part to be returned to the factory to determine the cause of failure. Peterson will pay freight charges if the product or part is determined to be defective. This warranty does not cover breakage in shipment from our independent distributor to its customer if the damage is determined to have occurred during that shipment.

This warranty specifically excludes liability for **indirect, incidental, or consequential** damages. Some states and provinces do not allow the exclusion or limitation of incidental or consequential damages, so the above exclusion may not apply to you. This warranty gives you specified legal rights, and you may have other rights that vary from state to state or province.

For additional information regarding this warranty, or to place a warranty claim, contact the R.H. Peterson dealer where the product was purchased.

When contacting your Peterson dealer or the R.H. Peterson Co., please provide the following information:

- Your name, address, telephone number, e-mail
- Sales receipt showing where purchased and date purchased
- Model number, serial number of product, date code
- Relevant information: installer, additions, repairs, when defect was first noted

**TO REGISTER YOUR PRODUCT ONLINE GO TO: WWW.RHPETERSON.COM,
AND CLICK ON PRODUCT REGISTRATION. THANK YOU FOR YOUR PURCHASE.**

FOR USE IN THE COMMONWEALTH OF MASSACHUSETTS

INSTALLATION OF THIS APPLIANCE MUST BE IN COMPLIANCE WITH 248 CMR: BOARD OF STATE EXAMINERS OF PLUMBERS AND GAS FITTERS AND PERFORMED BY A MASSACHUSETTS LICENSED PLUMBER OR GAS FITTER ONLY.

CONNECTOR KITS USED FOR INSTALLATION AND OPERATION OF THIS APPLIANCE MUST NOT BE MORE THAN 36" IN LENGTH.

FIREPLACE DAMPER MUST BE REMOVED OR PERMANENTLY FIXED/WELDED IN FULL OPEN POSITION PRIOR TO INSTALLING THIS PRODUCT.

Quality Check

Date: _____

Burner Orifices	Nat.	Leak Test:	_____	Model#:	_____
Main:	_____	Burn Test:	_____	Serial#:	_____
Other:	_____	Gas Type:	Nat. _____	Air Shutter:	_____
				Inspector:	_____