

42" Half-Moon Burner

Page Number	1 of 1
Author: Bryant Uribe	9/28/2018
Approved By: Gabriel Estrada	Date

SKU	Length, Width, Height (LxWxH)	Weight	Hub Size	BTU Output	Material
OPT-HM42	42" x 21" x 1"	9 lbs.	3/4"	150,000	Stainless Steel

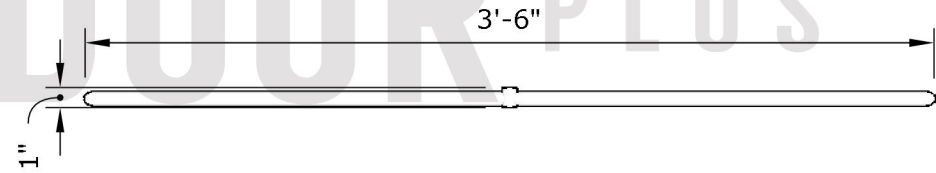
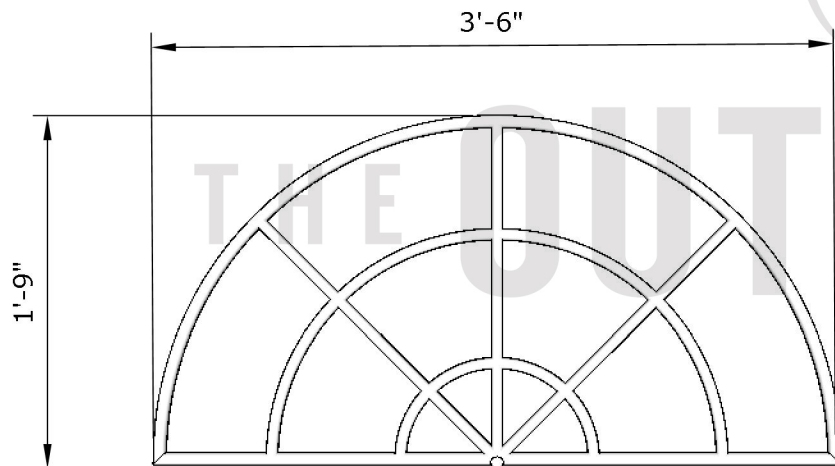
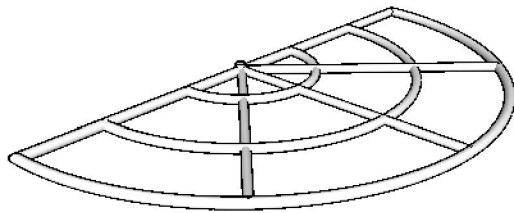

Proprietary & Confidential: The information contained in this drawing is the sole property of **The Outdoor Plus**. Any reproduction or as a whole without written permission of **The Outdoor Plus** is prohibited.