

ROUND FLAT PAN & ROUND BURNERS MATCH LIT IGNITION

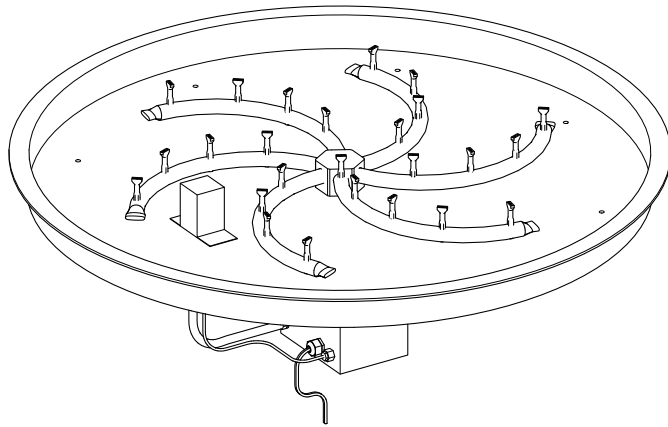

ISOMETRIC VIEW

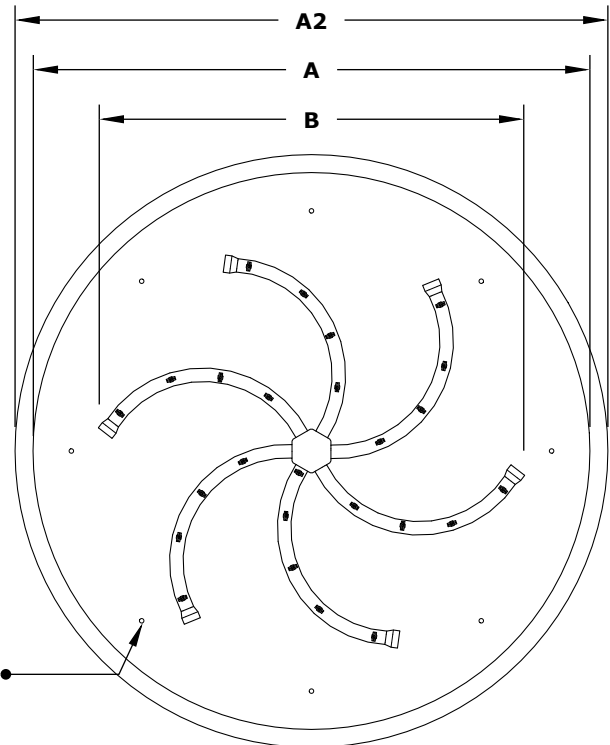

TOP VIEW

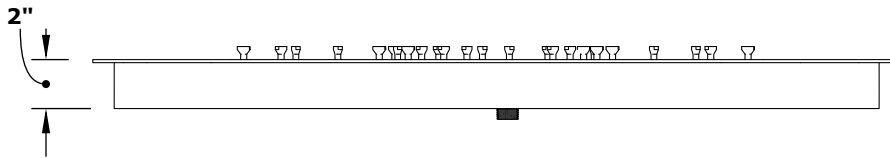

FRONT SIDE VIEW

SKU	A	A2	B	C	INLET	BTU
OPT-BP13RD	13"	15"	8"	2"	1/2" FIP	65,000
OPT-BP19RD	19"	21"	12"	2"	1/2" FIP	100,000
OPT-BP25RD	25"	27"	18"	2"	1/2" FIP	150,000
OPT-BP31RD	31"	33"	24"	2"	1/2" FIP	200,000
OPT-BP37RD	37"	39"	30"	2"	3/4" FIP	250,000
OPT-BP43RD	43"	45"	36"	2"	3/4" FIP	300,000

Pan Material: 304 Stainless Steel
 Burner Material: 304 Stainless Steel
 Ignition Type: Match Lit
 Includes: Pan and Burner

ROUND FLAT PAN & ROUND BURNERS 12V ELECTRONIC IGNITION

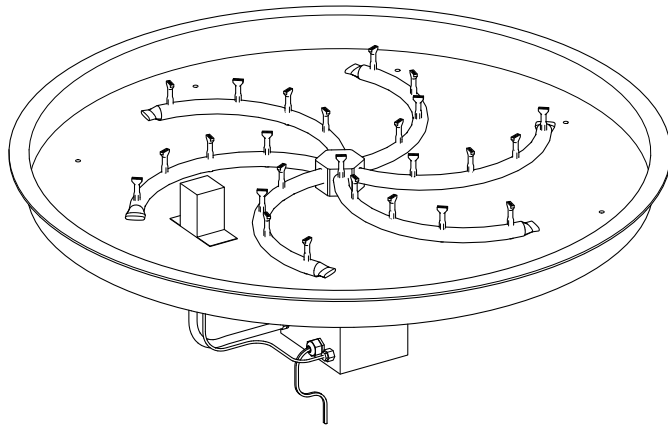

ISOMETRIC VIEW

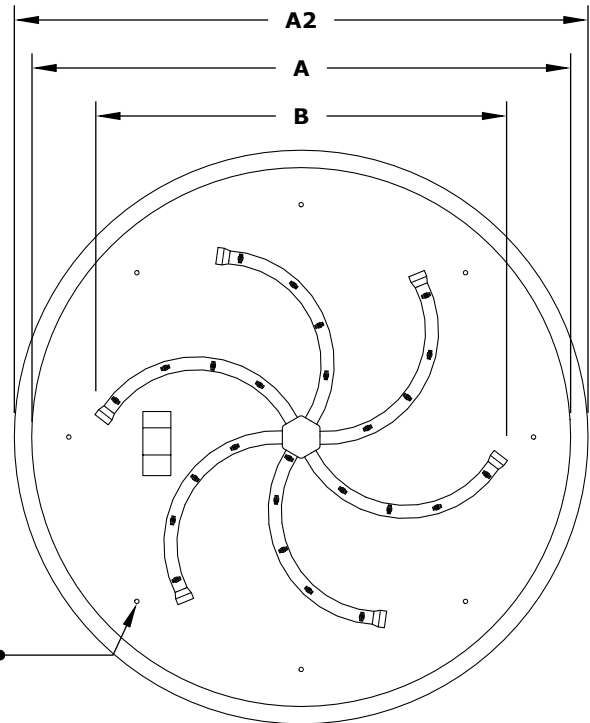

TOP VIEW

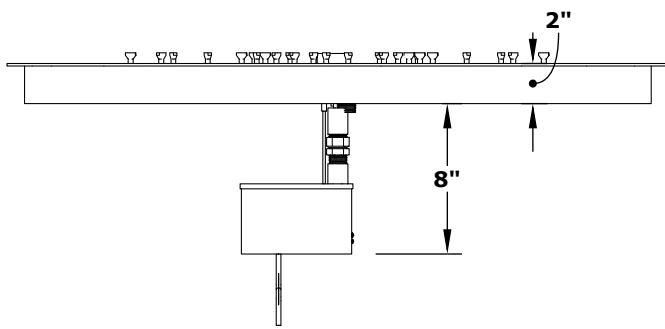

RIGHT SIDE VIEW

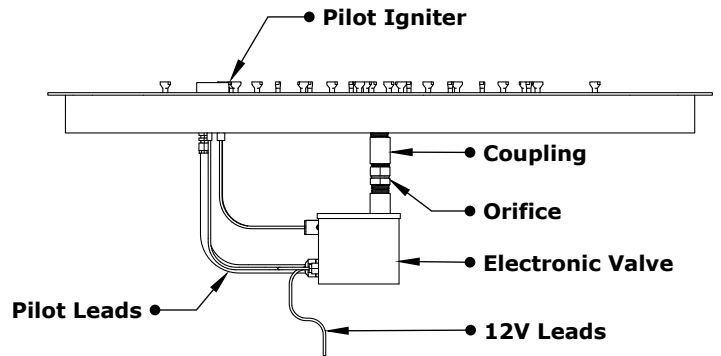

FRONT SIDE VIEW

SKU	A	A2	B	C	INLET	BTU
OPT-BP13RDE12	13"	15"	8"	2"	1/2"	65,000
OPT-BP19RDE12	19"	21"	12"	2"	1/2"	100,000
OPT-BP25RDE12	25"	27"	18"	2"	1/2"	150,000
OPT-BP31RDE12	31"	33"	24"	2"	1/2"	200,000
OPT-BP37RDE12	37"	39"	30"	2"	3/4"	250,000
OPT-BP43RDE12	43"	45"	36"	2"	3/4"	300,000

Pan Material: 304 Stainless Steel
Burner Material: 304 Stainless Steel
Ignition Type: 12V Electronic Ignition
(12V Transformer Included)

12V ELECTRONIC IGNITION
ANSI Z21.97-(2017) / CSA 2.41-(2017)



Includes: Pan, Burner, Electronic Valve, Pilot Igniter. 12V Transformer.